



**ATILIM ALÜMİNYUM**



**2024**  
**Product Catalog**

# TABLE OF CONTENTS

▶ ALUMINUM RULER SET	4-5
▶ DECORATION - ALUMINUM TILE TRIMS - CABLE CHANNELS	6-10-11
▶ CURTAIN RAIL AND ACCESSORIES	12-14
▶ CABLE TIES - NAILS - CRAFT KNIFE	15-17
▶ TAPES - PLASTER MESH	18-19
▶ CONSTRUCTION SITE - OCCUPATIONAL SAFETY - TROWELS - GLOVES - ADHESIVES	20-27
▶ LADDERS	28-31
▶ ALUMINUM - PFC GRILLES	32-33
▶ PVC DOWEL - CERAMIC SET	34-41
▶ TRAFFIC SAFETY PRODUCTS - SCREWS - HIGIENE PRODUCTS	42-45
▶ SUSPENDED CEILING PROFILE SET AND ACCESSORIES	46-49
▶ SPAN SETS AND GARDEN GROUPS	50-51
▶ FURNITURE - HARDWARE - METALWARE	52-79
▶ ALUMINUM FURNITURE PROFILES	82-99
▶ ALUMINUM FURNITURE HANDLES (SIZED)	100-101
▶ ALUMINUM FURNITURE MECHANISMS	102-103



## ABOUT US

Atılım, founded in Istanbul in 1993, is growing with the strength it receives from the customer satisfaction it creates every day. Atılım Aluminum, which aims to have a say in the world Sunday with an understanding that does not compromise on quality, also wants to sign important projects abroad.

## OUR VISION

To become a learning and developing organization by making quality a way of life in our company and affiliated institutions.  
To reach the leading position of the aluminum sector by keeping up with the changes and innovations in the sector.

## OUR MISSION

To ensure efficiency and efficiency in all dealers and sub-dealers affiliated to our company in accordance with the moral and legal rules of trade.

To contribute to the development of our trade by providing examination, research, consultancy and training services for personnel in order to improve quality, to evaluate the management continuously and to make the development activities continuous.



# MASTAR®

SIVA MASTARLARI



## TILE MONTAR 20x40 mm

CODE	PRODUCT	PIECE
1001	TILE MONTAR 20x40 mm	10



## PLASTERING MONTAR 30x70 mm-25x65 mm

CODE	PRODUCT	PIECE
1003	Plastering Montar 30x70	10
1004	Plastering Montar 25x65	10



## EXTRA MONTAR 32x75 mm

CODE	PRODUCT	PIECE
1002	32x75 Extra Montar	10



## EXTRA MONTAR 40x80 mm

CODE	PRODUCT	PIECE
1005	40x80 Extra Montar	6



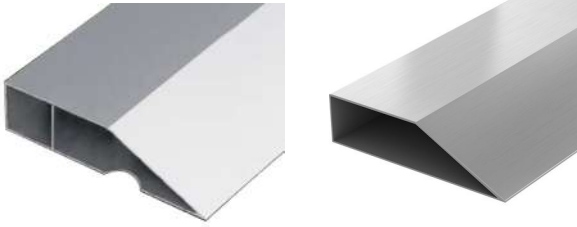

#### BACKING KNIFE COMPOUND-KNIFE PUTTY

CODE	PRODUCT	PIECE
1006	Backing Knife Compound	10
1007	Knife putty	10

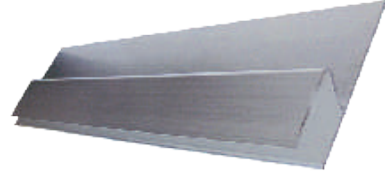

#### H MONTARI

CODE	PRODUCT	PIECE
1008	H Montar	4



#### ANO BAR

CODE	PRODUCT	PIECE
1009	ANO BAR 5 mm 270-300cm	30
1010	ANO BAR 7 mm 270-300cm	30



#### PRESSURE PLATE

CODE	PRODUCT	PIECE
1011	Pressure plate 300 cm	50



#### BACKED KNIFE PUTTY PRO

CODE	PRODUCT	PIECE
1012	Backed knife putty pro	10



#### BACKED PUTTY PRO

CODE	PRODUCT	PIECE
1013	Backed putty pro	10



#### ROUGH PLASTER CORNER BEAD

CODE	PRODUCT	PIECE
1014	Galvanized Rough Plaster Corner Bead /270-300cm	100
1015	Aluminum Rough Plaster Corner Bead /270-300cm	100

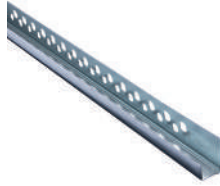

#### GALVANIZED PLASTER CORNER PROFILE

CODE	PRODUCT	PIESE
1016	Galvanized Plaster Corner Profile /270-300cm	50



#### DETAIL U PROFILE

CODE	PRODUCT	PIECE
1017	Detail U Profile	50

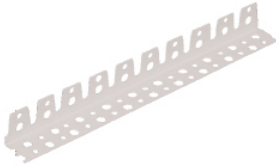

#### PVC PLASTER CORNER PROFILE

CODE	PRODUCT	PIECE
1018	PVC Plaster Corner Profile /250-270cm	50



#### PVC MOVABLE PLASTER CORNER PROFILE

CODE	PRODUCT	PIECE
1019	PVC Movable Plaster Corner Profiles	100

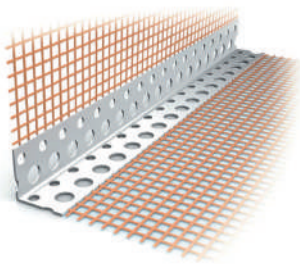

#### ALUMİNUM PLASTER CORNER PROFILE

CODE	PRODUCT	PIECE
1020	Aluminum Plaster Corner Profile 270cm	50

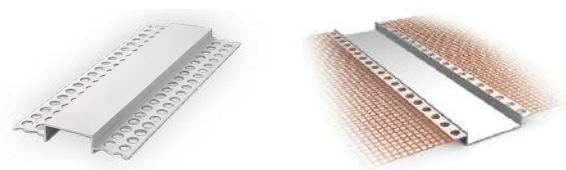

#### WIRE MESH CORNER

CODE	PRODUCT	PIECE
1021	PVC Mesh Corner Profile/ 250cm	100

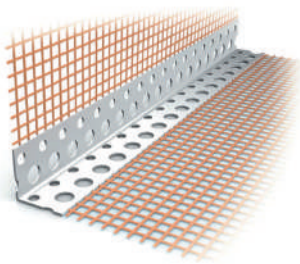

#### GROUT AND REINFORCED GROUT

CODE	PRODUCT	PIECE
1022	Grout 3.2mt, 4.2mt, 5.2mt	25
1023	Reinforced Grout 3.2mt, 4.2mt, 5.2mt	25

#### PVC WINDOW SILL PROFILE

CODE	PRODUCT	PIECE
1024	PVC Window Sill Profile 5,5	100
1025	PVC Window Sill Profile 7,5	100
1026	PVC Window Sill Profile 9,5	100



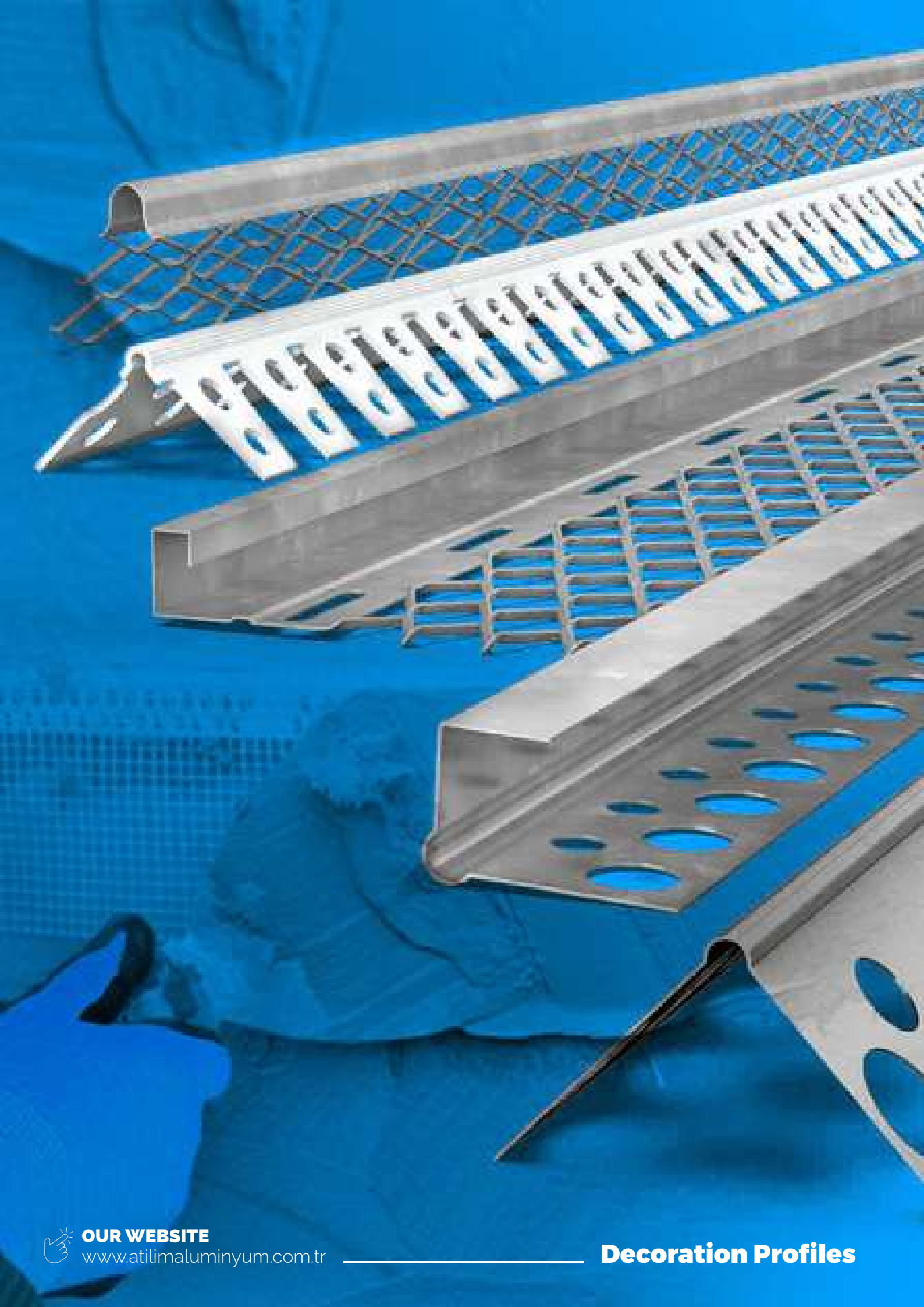

**OUR WEBSITE**

[www.atilimaluminyum.com.tr](http://www.atilimaluminyum.com.tr)

**Decoration Profiles**

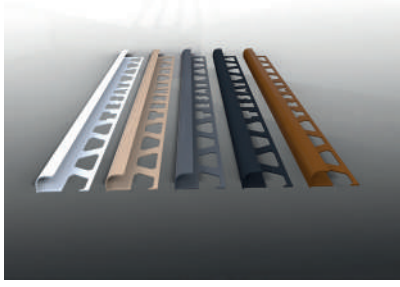

#### PVC EXTERNAL CORNER TILE PROFILES

CODE	PRODUCT	PIECE
1027	PVC External Corner Tile Profile 10mm 270cm	100
1028	PVC External Corner Tile Profile 12mm 270cm	100
Color	White - Beige - Gray - Black - Brown	

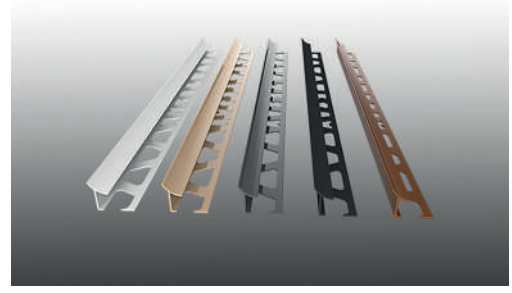

#### PVC INTERNAL CORNER TILE PROFILES

CODE	PRODUCT	PIECE
1030	PVC Internal Corner Tile Profile 10mm 270cm	100
1031	PVC Internal Corner Tile Profile 12mm 270cm	100
Color	White - Beige - Gray - Black - Brown	



#### ALUMINUM EXTERNAL CORNER TILE PROFILES

CODE	PRODUCT	PIECE
1033	10mm/Matte-Yellow-Glossy/270cm	100
1034	12mm/Matte-Yellow-Glossy/270cm	100



#### ALUMINUM INTERNAL CORNER TILE PROFILES

CODE	PRODUCT	PIECE
1035	10mm /270cm/Matte-Yellow-Glossy	60
1036	12mm/270cm/Matte-Yellow-Glossy	60

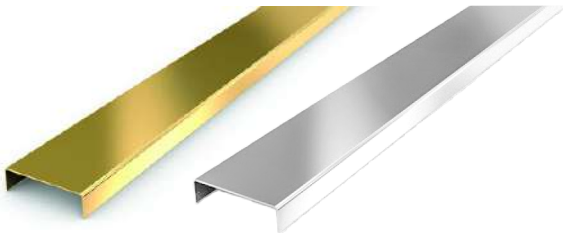

#### STAINLESS STEEL BORDER PROFILE

CODE	PRODUCT	PIECE
1037	Border Profile	50
Color	Yellow Mirror Glossy-Black-Bronze	50

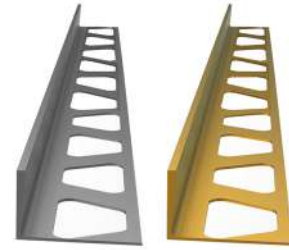

#### FINISHING PROFILES

CODE	PRODUCT	PIECE
1039	Aluminum Tile Edging 10mm	50
1040	Aluminum Tile Edging Profile 12mm	50
Color	Matte - Glossy - Yellow	



#### PARQUET FLOORING SPACER

CODE	PRODUCT	PACKAGE
1042	Parquet Flooring Spacer	50

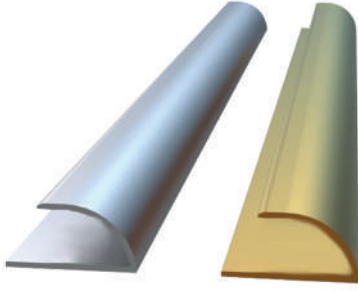

#### ALUMINUM CARPET FINISHING PROFILE

CODE	PRODUCT	PIECE
1043	Aluminum Carpet Finishing Profile 270 cm	50
Color	Matte Anodized-Yellow Anodized	



#### ALUMINUM STAIR NOSE F PROFILE

CODE	PRODUCT	PIECE
1045	Aluminum Stair Nose F Profile 10mm 250 cm	50
1046	Aluminum Stair Nose F Profile 12mm 250 cm	50
Color	Matte Anodized-Yellow Anodized	



#### ALUMINUM STAIR NOSE C PROFILE

CODE	PRODUCT	PIECE
1048	Aluminum Nose O Profile 10mm 250 cm	50
1049	Aluminum Nose O Profile 12mm 250 cm	50
Color	Matte Anodized-Yellow Anodized	

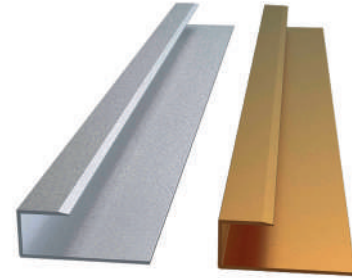

#### ALUMINUM LAMINATE FLOORING FINISHING PROFILE

CODE	PRODUCT	PIECE
1051	Laminate Flooring Finishing Profile 270cm/ Yellow	50
1052	Laminate Flooring Finishing Profile 270cm/ Matte	50

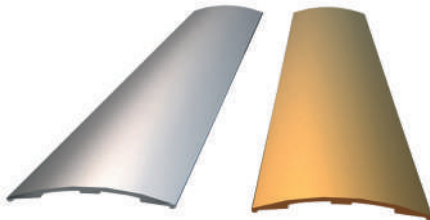

#### ALUMINUM TRANSITION PROFILE WITH TAPE

CODE	PRODUCT	PIECE
1053	Aluminum Transition Profile with Tape 270 cm	50
COLOR	Matte Anodized-Yellow Anodized	

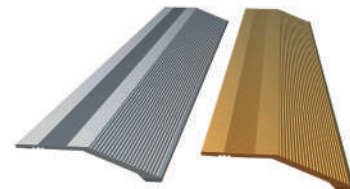

#### ALUMINUM LEVEL DIFFERENCE PROFILE

CODE	PRODUCT	PIECE
1055	Level Difference Profile/ 270cm / Yellow	50
1056	Level Difference Profile/ 270cm / Matte	50





#### ALUMİNUM STAIR STEP PROFILE

CODE	PRODUCT	PIECE
1057	Aluminum Stair Step Profile 10mm	40
1058	Aluminum Stair Step Profile 12mm	40
Color	Matte Anodized - Yellow Anodized	

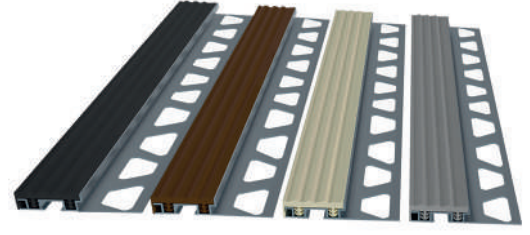

#### RUBBER STAIR TREAD PROFILE

CODE	PRODUCT	PIECE
1060	RSTP /250cm//10mm/ Matte-Yellow-Glossy	40
1061	PSTP/250cm/12mm/ Matte-Yellow-Glossy	40

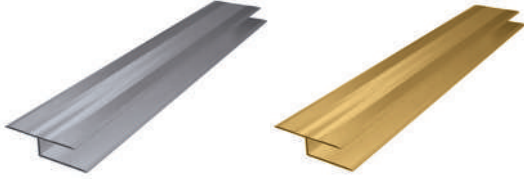

#### ALUMİNUM Z PROFILE

CODE	PRODUCT	PIECE
1062	Z Profile/ 270cm / Yellow	50
1063	Z Profile / 270cm / Matte	50



#### ALUMİNUM BALUSTRADE CLOTHES LINE

CODE	PRODUCT	PIECE
1064	Aluminum Balustrade Clothes Line	24



#### PVC BATHTUB EDGE TRİM

CODE	PRODUCT	PIECE
1065	Bat. E.Trim. 250cm 33x33 White-Gray Fixed	24
1066	Bat. E.Trim 250m 33x33 White-Gray Sleigh	24
1067	Bathtub Edge Trim 250cm 15x15 White	40
1068	Bathtub Edge Trim 250cm 50x50 White	12



#### PVC BASEBOARDS

CODE	PRODUCT	PIECE
1069	PVC Baseboards 250 cm / 90 mm - 60 mm	48
Color	Black - White - Walnut - Mastic Gray	

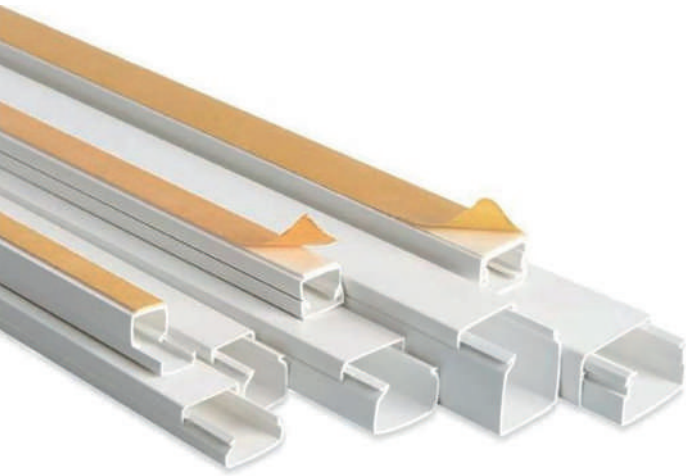

#### ADHESIVE CABLE CHANNEL

CODE	DİMENŞİYON	PRODUCT	BOX/M
1071	12 x 12	Adhesive Cable Channel - Boxed 2,5m	320
1072	15 x 10	Adhesive Cable Channel - Boxed 2,5m	300
1073	16 x 16	Adhesive Cable Channel - Boxed 2,5m	180
1074	20 x 10	Adhesive Cable Channel - Boxed 2,5m	240
1075	25 x 16	Adhesive Cable Channel - Boxed 2,5m	154
1076	25 x 25	Adhesive Cable Channel - Boxed 2,5m	96
1077	30 x 20	Adhesive Cable Channel - Boxed 2,5m	100
1078	40 x 16	Adhesive Cable Channel - Boxed 2,5m	84
1079	40 x 25	Adhesive Cable Channel - Boxed 2,5m	80
1080	40 x 40	Adhesive Cable Channel - Boxed 2,5m	72
1081	50 x 50	Adhesive Cable Channel - Boxed 2,5m	48
1082	60 x 40	Adhesive Cable Channel - Boxed 2,5m	48
1083	60 x 60	Adhesive Cable Channel - Boxed 2,5m	40



## Plastic Cable Trays



**OUR WEBSITE**

[www.atilimaluminyum.com.tr](http://www.atilimaluminyum.com.tr)



CLASSRAY®

#### SINGLE CURTAIN RAIL

CODE	PRODUCT	PIECE
1084	Single Curtain Rail	20



CLASSRAY®

#### 2-LAYERED CURTAIN RAILS

CODE	PRODUCT	PIECE
1085	2-Layered Curtain Rails	20



CLASSRAY®

#### TRIPLE CURTAIN RAILS

CODE	PRODUCT	PIECE
1086	Triple Curtain Rails	10



CLASSRAY®

#### 4-LAYERED CURTAIN RAILS

CODE	PRODUCT	PIECE
1087	4-Layered Curtain Rail	10



CLASSRAY®

#### 3-LAYERED CARDBOARD PANEL RAIL

CODE	PRODUCT	PIECE
1089	3-Layered Cardboard Panel Rail	4



CLASSRAY®

#### CARDBOARD PANEL RAIL INNER - OUTER CORNER

CODE	PRODUCT	PIECE
1090	Cardboard Panel Rail Inner Corner	8
1091	Cardboard Panel Rail Outer Corner	4



CLASSRAY®

#### STRAIGHT PANEL RAIL

CODE	PRODUCT	PIECE
1092	Straight Panel Rail	4



CLASSRAY®

#### WALL AND CEILING PANELING GROUP

CODE	PRODUCT	PIECE
1094	20 cm Paneling	10



**OUR WEBSITE**

[www.atilimaluminyum.com.tr](http://www.atilimaluminyum.com.tr)

**Curtain Rails**



**CLASSRAY®**

**ALUMINUM TRIPLE CURTAIN RAIL**

CODE	PRODUCT	PIECE
1096	Aluminum Curtain Rail 3-Layered	10



**CLASSRAY®**

**ALUMINUM CURTAIN RAIL 2-LAYERED**

CODE	PRODUCT	PIECE
1097	Aluminum Double Curtain Rail	10

**CLASSRAY®**

**VENETIAN BLIND RODS - VENETIAN BLIND HEADERS**

CODE	PRODUCT	PIECE
1098	Venetian Blind Slats 2m-3m Yellow	50
1099	Venetian Blind Slats 2m-3m White	50
1100	Venetian Blind Slats/Yellow	100
1101	Venetian Blind Slats/White	100



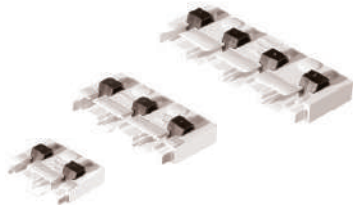

CLASSRAY®

#### CURTAIN RAIL ACCESSORIES FINIALS

CODE	PRODUCT	PIECE
1102	Double Finial	60
1103	Triple Finial	60
1104	Quadruple Finial	60



CLASSRAY®

#### CURTAIN RAIL ATTACHMENTS

CODE	PRODUCT	PIECE
1105	2-Piece Attachment	60
1106	3-Piece Attachment	60
1107	4-Piece Attachment	60



CLASSRAY®

#### RAY APPARATUS ROTATIONS 45°

CODE	PRODUCT	PIECE
1108	Double Rotation 45°	60
1109	Triple Rotation 45°	60



CLASSRAY®

#### RAY APPARATUS ROTATIONS 90°

CODE	PRODUCT	PIECE
1110	Double Rotation	50
1111	Triple Rotation	50
1112	Quadruple Rotation	50



CLASSRAY®

#### PVC AUTOMATIC L LEG

CODE	PRODUCT	PIECE
1113	PVC Automatic L Leg	60



CLASSRAY®

#### ORIENTAL BEAM - ORIENTAL BEAM APPARATUS

CODE	PRODUCT	PIECE
1114	Oriental Beam (As a Set)/5-10-15-20m	1
1115	Oriental Beam Depiction	100
1116	Oriental Beam Roller	100
1117	Oriental Beam Spiral	100
1118	Oriental Beam Cover	100

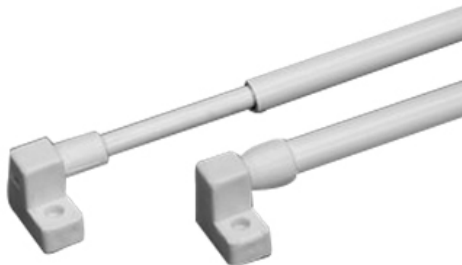

#### TELESCOPIC GAZEBO POLE

CODE	PRODUCT	PIECE
1119	Telescopic Flagpole	20
1120	40 X 60 - 60 X 80 - 80 X 100	20



#### IRON L LEG - PORTRAITS

CODE	PRODUCT	PIECE
1121	Single Portrait	250
1122	Double Portrait	300
1123	Iron L Leg 10cm	100





### PLASTIC CABLE TIE - CLAMP

CODE	DİMENZYON	PRODUCT	PACKAGE	BOX
1124	2,5 x 100	Plastic Cable Tie - Clamp - Black / White	100	50.000
1125	2,5 x 150	Plastic Cable Tie - Clamp - Black / White	100	40.000
1126	2,5 x 200	Plastic Cable Tie - Clamp - Black / White	100	25.000
1127	3,6 x 150	Plastic Cable Tie - Clamp - Black / White	100	25.000
1128	3,6 x 200	Plastic Cable Tie - Clamp - Black / White	100	20.000
1129	3,6 x 250	Plastic Cable Tie - Clamp - Black / White	100	18.000
1130	3,6 x 300	Plastic Cable Tie - Clamp - Black / White	100	17.000
1131	3,6 x 370	Plastic Cable Tie - Clamp - Black / White	100	15.000
1132	4,8 x 200	Plastic Cable Tie - Clamp - Black / White	100	18.000
1133	4,8 x 250	Plastic Cable Tie - Clamp - Black / White	100	15.000
1134	4,8 x 300	Plastic Cable Tie - Clamp - Black / White	100	14.000
1135	4,8 x 380	Plastic Cable Tie - Clamp - Black / White	100	12.000
1136	4,8 x 450	Plastic Cable Tie - Clamp - Black / White	100	9.000
1137	4,8 x 500	Plastic Cable Tie - Clamp - Black / White	100	7.000
1138	8,0 x 300	Plastic Cable Tie - Clamp - Black / White	100	6.000
1139	8,0 x 380	Plastic Cable Tie - Clamp - Black / White	100	5.000
1140	8,0 x 450	Plastic Cable Tie - Clamp - Black / White	100	4.500
1141	8,0 x 550	Plastic Cable Tie - Clamp - Black / White	100	3.000
1142	8,0 x 650	Plastic Cable Tie - Clamp - Black / White	100	2.500
1143	8,0 x 750	Plastic Cable Tie - Clamp - Black / White	100	2.500



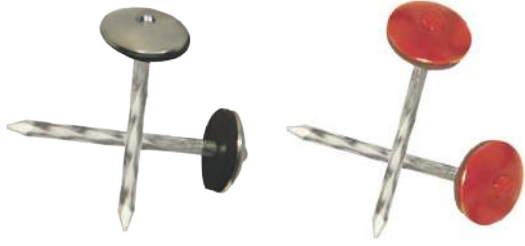

#### METAL-HEAD ROOFING NAIL

CODE	PRODUCT	KG
1144	Galvanized Headed Metal Roofing Nail 8-Pack	25KG
1145	Red-Headed Metal Roofing Nail 8-Pack	25KG
1146	Galvanized Headed Metal Roofing Nail 10-Pack	25KG
1147	Red-Headed Metal Roofing Nail 10-Pack	25KG



#### PLASTIC-HEADED ROOFING NAIL

CODE	PRODUCT	PIECE
1148	Red-Headed Plastic Roofing Nail 8-Pack.	400
1149	Green-Headed Plastic Roofing Nail 8-Pack.	400
1150	Red-Headed Plastic Roofing Nail 10-Pack.	400
1151	Green-Headed Plastic Roofing Nail 10-Pack.	400



#### RIDGE CAP

CODE	PRODUCT	PIECE
1152	RIDGE TILE 20 x 40	1000
1153	RIDGE CAP 42 x 45	1000



#### UPİM

CODE	PRODUCT	PIECE
1154	INSULATION NAIL 40 MM	500
1155	INSULATION NAIL 60 MM	500
1156	INSULATION NAIL 80 MM	500
1157	INSULATION NAIL 100 MM	500



#### TYPES OF TWINE

CODE	PRODUCT	GRAM	PIECE
1158	Broom Twine	50	600
1159	Broom Twine	70	500
1160	Broom Twine	100	400
1161	Broom Twine	200	192
1162	Broom Twine	400	108



#### MOORING ROPE

CODE	PRODUCT	PIECE
1163	Sheet Rope 3-4-5-6-8-10-12-14-16-18mm	18-22KG



#### METAL MODEL KNIFE

CODE	PRODUCT	BOX
1064	METAL MODEL KNIFE	192



#### PLASTIC MODEL KNIFE

CODE	PRODUCT	BOX
1065	PLASTIC MODEL KNIFE	192

#### PVC MODEL KNIFE

CODE	PRODUCT	BOX
1065-1	PVC MODEL KNIFE	288





#### MASKING TAPE

CODE	PRODUCT	PIECE
1166	Masking Tape/18mm	144
1167	Masking Tape/24mm	108
1168	Masking Tape/36mm	72
1169	Masking Tape/48mm	36



#### FOAM TAPE

CODE	PRODUCT	PIECE
1170	Foam Tape 3x19mm 5x19mm 10x19mm 25x19mm	4



#### DUCT TAPE - HANDYMAN'S TAPE

CODE	PRODUCT	PIECE
1171	Handyman's Tape 10m	36
1172	Handyman's Tape 40m	12



#### PACKING TAPE

CODE	PRODUCT	PIECE
1173	Packing Tape/48mmx100m/ Transparent	72
1174	Packaging Tape/48mmx100m/R.color	72
1175	Double-Sided Film Tap 50mm/25m	72



#### NON-SLIP LADDER

CODE	PRODUCT	PIECE
1176	Non-Slip Stair Tread Tape 25mmx15m	24
1177	Non-Slip Stair Tread Tape 50mmx15m	12

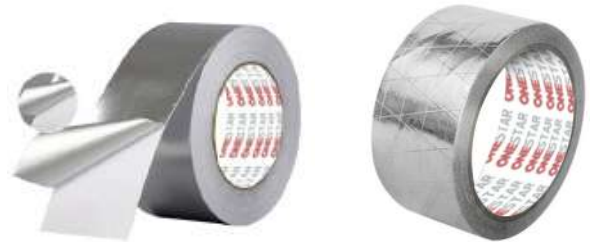

#### ALUMINUM FOIL TAPE

CODE	PIECE	PIECE
1178	Plain Foil Tape/48mmx10m-20m	48
1179	Plain Foil Tape/96mmx10m	24
1180	Reinforced Aluminum Tape/48mmx10-20m	48
1181	Reinforced Aluminum Tape/96mmx10m	24





**ONESTAR®**

**75gr  
FIBERGLASS MESH  
100cmX50m**



**ONESTAR®**

**160gr  
FIBERGLASS MESH  
100cmX50m**



#### PLASTER MESH

CODE	PRODUCT	PIECE
1182	Plaster Mesh/160gr m2/ Orange	2
1183	Plaster Mesh/75gr m2/White	2

#### JOINT TAPE

CODE	PRODUCT	PIECE
1184	Joint Tape 50x45mm	72
1185	Joint Tape 50x90mm	36
1186	Joint Tape 100x90mm	18

#### Areas of Use:

- \*In thermal insulation and cladding applications for interior and exterior facades
- \* For repair plasters to be applied on existing cracks
- \* To prevent possible cracks at the junctions of load-bearing elements in buildings
- \* In the application of cementitious, plastic-modified elastic waterproofing materials



**OUR WEBSITE**

[www.atilimaluminyum.com.tr](http://www.atilimaluminyum.com.tr)

**Plaster Mesh / Joint Tape**





#### CONSTRUCTION SITE BUNK BED

CODE	PRODUCT	PIECE
1187	80x180 (1mm)	1
1188	90x190 (1mm)	1



#### CONSTRUCTION SITE BLANKET

CODE	PRODUCT	PIECE
1189	Blanket	1



#### CONSTRUCTION SITE BEDDING SET

CODE	PRODUCT	PIECE
1190	Bedding set	1



#### CONSTRUCTION SITE PILLOW

CODE	PRODUCT	PIECE
1191	Construction site pillow	1



#### CONSTRUCTION SITE BED

CODE	PRODUCT	PIECE
1192	Bed	1



#### SAFETY GOGGLES

CODE	PRODUCT	PIECE
1193	Clear-Green-Blue-Yellow-Smoke-Red-Tinted Glasses	500



#### PARACHUTE-TYPE SAFETY HARNESS

CODE	PRODUCT	PIECE
1194	Parachute-style safety belt	20



#### ADJUSTABLE BERET

CODE	PRODUCT	PACKAGE
1195	Adjustable Beret - Yellow - White - Blue - Orange - Green - Red	25

#### MANUAL BERET

CODE	PRODUCT	PACKAGE
1196	Manual Beret - Yellow - White - Blue - Orange - Green - Red	30



#### BUMP CAP WITH IMPACT ABSORPTION

CODE	PRODUCT	PIECE
1197	Bump Cap	50

#### FLUORESCENT SAFETY VEST

CODE	PRODUCT	PIECE
1198	Fluorescent Yellow-Orange Safety Vest	500



#### ENGINEER TYPE HIGH-VISIBILITY VEST YELLOW ORANGE

CODE	PRODUCT	PIECE
1199	Engineer Type High-Visibility Vest Yellow-Orange	100

#### PLASTIC CHAIN

CODE	PRODUCT	PIECE
1200	Plastic Chain	100M



#### SAFETY BARRIER

CODE	PRODUCT	PIECE
1201	Safety Barrier 1x150mt	1

#### SAFETY WARNING TAPE LARGE - SMALL

CODE	PRODUCT	PIECE
1202	Small Safety Warning Tape	24
1203	Small Safety Warning Tape	12

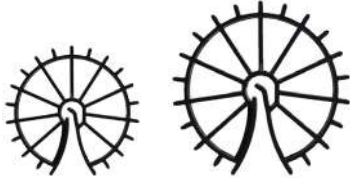

### CURTAIN HOOKS

CODE	PRODUCT	PIECE
1221	Curtain Tape/15mm/6-12mm	2.500
1222	Curtain Tape/20mm/6-12mm	2.500
1223	Curtain Tape/25mm/6-14mm	2.000
1224	Curtain Tape/30mm/8-12mm	1.000
1225	Curtain Tape/40mm/12-16mm	750
1226	Curtain Tape/50mm/8-16mm	400
1227	Curtain Tape/75mm/8-32mm	200

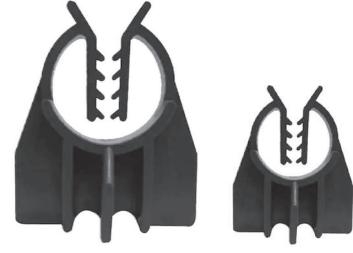

### STANDARD HOOKS

CODE	PRODUCT	PIECE
1228	Standard Hook/20mm/8-24mm	1.000
1229	Standard Hook/25mm/8-24mm	1.000
1230	Standard Hook/30mm/8-24mm	1.000
1231	Standard Hook ı/40mm/8-24mm	750
1232	Standard Hook/50mm/8-24mm	500
1233	Standard Hook/75mm/8-24mm	250



### UPHOLSTERY CLIPS

CODE	PRODUCT	PIECE
1234	Upholstery Tacks 15mm/8-12mm	3.000
1235	Upholstery Tacks 20mm/6-18mm	2.500
1236	Upholstery Tacks 25mm/6-18mm	2.500
1237	Upholstery Tacks 30mm/6-18mm	2.000
1238	Upholstery Tacks 75mm/10-20mm	500

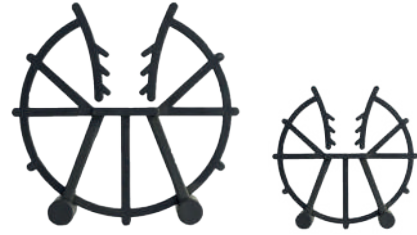

### UPHOLSTERY CURTAIN HOOKS

CODE	PRODUCT	PIECE
1239	Upholstery Curtain Tape/25mm/6-18mm	2.000
1240	Upholstery Curtain Tape/30mm/618mm	2.000



### HOOP FASTENERS

CODE	PRODUCT	PIECE
1241	Hoop Clip/15mm/100mm	500
1242	Hoop Clip/20mm/200mm	500
1243	Hoop Clip/25mm/200mm	500



### PARALLEL FASTENERS

CODE	PRODUCT	PIECE
1244	Parallel Fastener/15mm/215mm	500
1245	Parallel Fastener/20mm/215mm	500
1246	Parallel Fastener/25mm/215mm	500
1247	Parallel Fastener/30mm/215mm	500



#### PAH PROFİLES

CODE	PRODUCT	PIECE
1248	Earless PAH Strip/White/300cm	50
1249	Earless PAH Strip/Brown/300cm	50



#### PAH PROFİLES

CODE	PRODUCT	PIECE
1250	Eared PAH Strip / White/ 300cm	50
1251	Eared PAH Strip / Brown/ 300cm	50



#### MOLD FUGUE

CODE	PRODUCT	PIECE
1252	Mold Fugue (Trapezoidal Fugue)/300cm	50



#### PİLE SHOE BRACKETS

CODE	PRODUCT	PIECE
1253	Pile Shoe Bracket/25mm/6-18mm	2.000
	Pile Shoe Bracket/30mm/6-18mm	2.000



#### TİE-ROD PIPE

CODE	PRODUCT	PIECE
1254	Tie-Rod Pipe/300cm	50



#### TİE-ROD PIPE CAP AND CONE

CODE	PRODUCT	PIECE
1255	Tie-Rod Pipe Cap/22-26	1.000
1256	Conical Plug	1.000



#### SAFETY PLUG

CODE	PRODUCT	PIECE
1257	Safety Plug 10 - 18	1000
1258	Safety Plug 18 - 32	500



#### STEEL FORM OİL / PLYWOOD WOOD FORM OİL

CODE	PRODUCT	KG
1259	Steel Form Oil 30lt	30
1260	Plywood Wood Form Oil 30lt	30



#### VARIETIES OF RESIN

CODE	PRODUCT	PIECE
1261	Chrome-Plated resin 3-4mm	50
1262	Painted Resin 3-4mm	50



#### RESIN MACHINE

CODE	PRODUCT	PIECE
1263	Manual Resin Machine	2



#### TIE ROD

CODE	PRODUCT	PIECE
1264	Tie Rod 80mm-Meter	10
1265	Tie Rod 100mm-Meter	10
1266	Tie Rod 120mm-Meter	10
1267	Tie Rod 150mm-Meter	10
1268	Tie Rod 200mm-Meter	10



#### TIE ROD NUT

CODE	PRODUCT	PIECE
1269	Tie Rod Nut 70	50
1270	Tie Rod Nut 90	50

#### TIE ROD ASSEMBLY



#### TIE ROD END

CODE	PRODUCT	PIECE
1271	Tie Rod End 10×10	50
1272	Tie rod end 12×12	50



#### MOVABLE CLAMP

CODE	PRODUCT	PIECE
1273	48mm Double Movable Clamp	25



#### SCAFFOLDING CLAMP

CODE	PRODUCT	PIECE
1274	Scaffolding Clamp	25





#### PALLET STRETCHES

CODE	PRODUCT	PIECE
1275	Pallet Stretches 17-23 Micron	6



#### PROTECTIVE RUSTLING COVER

CODE	PRODUCT	PIECE
1276	Protective Rustling Cover 10-20-30-40-50m <sup>2</sup>	25



#### YELLOW NITRILE GLOVES

CODE	PRODUCT	PIECE
1277	Yellow Nitrile Gloves	288



#### Red Zebra Gloves

CODE	PRODUCT	PIECE
1278	Red Zebra Gloves	288



#### BLUE ZEBRA GLOVES

CODE	PRODUCT	PIECE
1279	Blue Zebra Gloves	288



#### Yellow Cotton Nitrile Gloves

CODE	PRODUCT	PIECE
1280	Yellow Cotton Nitrile Gloves	288



#### GENERAL PURPOSE SILICONE

CODE	PRODUCT	PIECE
1204	General Purpose Silicon	24



#### MIRROR SILICONE

CODE	PRODUCT	PIECE
1205	Mirror Silicone	24



#### SILICONE / ACRYLIC SEALANT

CODE	PRODUCT	PIECE
1206	Siliconized Acrylic Sealant	24



#### MOUNTING FOAM

CODE	PRODUCT	PIECE
1207	Mounting Foam	16



#### INSTANT ADHESIVE

CODE	PRODUCT	PIECE
1208	MDF Adhesive 200ml - 400ml	20



#### GUN GRADE FOAM

CODE	PRODUCT	PIECE
1209	Gun Foam	16



### STRONG MOUNTING ADHESIVE - ULTRA TACK

CODE	PRODUCT	PIECE
1210	Strong Mounting Adhesive	12



### POLYSTYRENE ADHESIVE

CODE	PRODUCT	PIECE
1211	POLYSTYRENE ADHESIVE	12
1212	PU Sealant	12



### METAL EPOXY SILICONE GUN

CODE	PRODUCT	PIECE
1213	Metal Epoxy Silicone Gun	12



### METAL SILICONE GUN

CODE	PRODUCT	PIECE
1214	Metal Silicone Gun	24



### PVC SILICONE GUN

CODE	PRODUCT	PIECE
1215	PVC Silicone Gun	50



### MARBLE ADHESIVE - CHEMICAL ANCHOR

CODE	PRODUCT	PIECE
1216	Marble Adhesive/250 gr	12/24
1217	Marble Adhesive/500 gr	12/24
1218	Marble Adhesive/1000 gr-1200 gr	12/24
1219	Chemical Anchor 345ml	20
1220	Chemical Anchor 410ml	12

# ONESTAR® STAIRS

*Profesyonellerin Tercihii*



## Double Exit Staircase

- 3-step Staircase
- 4-step Staircase
- 5-step Staircase
- 6-step Staircase
- 7-step Staircase
- 8-step Staircase
- 9-step Staircase

The Double-Exit Stairs are light, practical and robust with wide steps that allow comfortable operation. Suitable for hobby and professional use.

**ONESTAR®**  
www.onestar.com.tr

## Multipurpose Staircase

- Gold Series Multipurpose Staircase**
- 12-step Staircase 16-step Staircase
- 20-step Staircase

- 3,70 meter
- 4,70 meter
- 5,70 meter

Multi-purpose stairs can be used for multiple purposes thanks to special joint-lock systems. due to the fact that they are 4-piece, they take up very little space when they close and can reach a size that can fit in the trunk of small vehicles.

Just as they can be used in the type A position without the need to rest anywhere, you can also use Multi-Purpose Stairs with a one-piece support. They can also easily come in the form of a platform at the same time.

**ONESTAR®**  
www.onestar.com.tr

## Telescopic Work Platform

- 2x2=4,0 Meter
- 2x2,5=5,0 Meter
- 2x3=6,0 Meter
- 2x3,5=7,0 Meter
- 2x4=8,0 Meter

The Safe Scaffolding System, which has just started to be produced in our country, is a safe scaffolding system that must be used abroad, which prioritizes occupational safety. Telescopic Scaffolding is a safer scaffolding system that can be used in wall construction, interior and exterior plaster construction, facade painting and insulation, facade cladding, ship construction and repair, high-curtain construction and maintenance such as dams, tunnels to ensure a comfortable and safe work production.

**ONESTAR®**  
www.onestar.com.tr

## 2-Piece PTT Ladder

- 2x2=4,0 Meter
- 2x2,5=5,0 Meter
- 2x3=6,0 Meter
- 2x3,5=7,0 Meter
- 2x4=8,0 Meter
- 2x5=10,0 Meter
- 2x6=12,0 Meter

Two-Piece Sliding Aluminum Stairs are used as two-stage and sliding. The height of the two-piece stairs can be easily attached and adjusted to the desired step with excellent steel hooks on the sliding part. It is durable and reliable thanks to the deadbolt and step lock system.



## 3-Piece PTT Ladder

- 6,0 MT A-Type Ladder
- 7,5MT A-Type Ladder
- 9,0 MT A-Type Ladder
- 10,5MT A-Type Ladder
- 12,0 MT A-Type Ladder
- 15,0 MT A-Type Ladder
- 18,0 MT A-Type Ladder

The height of the three-part stairs, which can be used as three-stage and sliding, can be adjusted by attaching steel hooks to the desired step. It is extremely durable and reliable. Three-Piece Sliding Aluminum Stairs can be used in the forms of one-piece stairs, 2-piece sliding stairs or 3-piece sliding stairs according to request.



## A-Type Ladder

- 2,0 MT A-Type Ladder
- 2,5MT A-Type Ladder
- 3,0 MT A-Type Ladder
- 3,5MT A-Type Ladder
- 4,0 MT A-Type Ladder
- 5,0 MT A-Type Ladder
- 6,0 MT A-Type Ladder

A-type aluminum stairs, which have the possibility of working without resting on any position, allow two people to work at the same time. The robust straps eliminate the risk of opening and ensure safe use. Its balance is stabilized with wide feet and the risk of slipping is eliminated with rubber shoes.



## A-Type Sliding Ladder

- 2,0 MT A-Type Ladder
- 2,5MT A-Type Ladder
- 3,0 MT A-Type Ladder
- 3,5MT A-Type Ladder
- 4,0 MT A-Type Ladder
- 5,0 MT A-Type Ladder
- 6,0MT A-Type Ladder

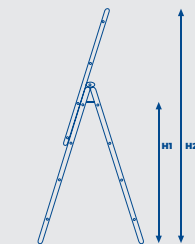

It is possible to reach higher by using the sliding part of the A-type sliding stairs, which can be used without resting on any place in its position. The opening is fixed with sturdy straps and the risk of slipping is eliminated with rubber shoes. The deadbolt and step lock system is extremely durable and reliable. If desired, the sliding part can be removed and used as two separate stairs.





# ONESTAR®

## SEKMEN

Ev Tipi Merdiven  
Home Type Ladders



[www.atilimaluminyum.com](http://www.atilimaluminyum.com)

[www.onestar.com](http://www.onestar.com)

CODE	Number of Digits	Height	Profile Size/Thickness
1281	2+1	1,18m	0,7mm / 21*47
1282	3+1	1,36m	0,7mm / 21*47
1283	4+1	1,60m	0,7mm / 21*47
1284	5+1	1,80m	0,7mm / 21*47
1285	6+1	2,01m	0,7mm / 21*47
1286	7+1	2,22m	0,7mm / 21*47
1287	8+1	2,43m	0,7mm / 21*47
1288	9+1	2,64m	0,7mm / 21*47

#### WHAT IS A SEKMEN?

Sekmen Anadolu Selçuklu and Ottoman period in the central Anatolian countryside of the Seljuk and Ottoman period is the name given to the ladder located at the entrance of houses built with stones with a height of 1-1.5 meters from the ground, still in the central Anatolian countryside, the sekmen located in front of houses with a high entrance are used.



CODE	Number of Digits	Height	Profile Size / Thickness
1289	1+1	90cm	1mm / Ø25
1290	2+1	112cm	1mm / Ø25
1291	3+1	132cm	1mm / Ø25
1292	4+1	155cm	1mm / Ø25

- \* Electrostatically baked painted metal body and steps
- Easy to open and close
- Ready-to-use single-style packaging
- \* Specially designed steps that prevent slipping
- \* Decorative use in homes and workplaces
- Security locked (EN-131)
- PVC Coated colored handle



### ALUMINUM SURFACE GRILLE

WHITE - ANODIZED - YELLOW ANODIZED - WOOD VENEER		
CODE	EN - HEIGHT	BOX
1293	20 x 20	10
1294	25 x 20	10
1295	25 x 25	10
1296	30 x 25	10
1297	30 x 30	10
1298	35 x 30	10
1299	35 x 35	10
1300	35 x 45	10
1301	40 x 40	10
1302	40 x 45	10
1303	40 x 50	10
1304	40 x 55	10
1305	40 x 60	10

WHITE - ANODIZED - YELLOW ANODIZED - WOOD VENEER		
CODE	EN - HEIGHT	BOX
1306	45 x 45	10
1307	45 x 50	10
1308	45 x 55	10
1309	50 x 40	10
1310	50 x 45	10
1311	50 x 50	10
1312	50 x 55	10
1313	50 x 60	10
1314	55 x 55	10
1315	55 x 60	10
1316	60 x 40	10
1317	60 x 50	10
1318	60 x 60	10



BATHROOM SHOWER CURTAIN PIPE		
CODE	PRODUCT	PIECE
1433-2	Bathroom Shower Curtain Pipe With Corners	30



BATHROOM SHOWER CURTAIN PIPE		
CODE	PRODUCT	PIECE
1433-3	Bathroom Shower Curtain Pipe Straight	30



### PLASTIC CULVERT

#### PLASTIC CULVERT

CODE	EN - HEIGHT	BOX
1319	28 x 35	15
1320	35 x 45	15
1321	45 x 45	15
1322	45 x 55	15
1323	55 x 55	15
1324	55 x 65	15

#### PLASTIC CULVERT

KOD	EN - BOY	KOLİ
1325	25 x 45	20
1326	35 x 35	20
1327	35 x 55	20
1328	40 x 40	20
1329	45 x 65	20
1330	50 x 50	20
1331	60 x 60	20
1332	65 x 65	20



#### BATHROOM CURTAIN

CODE	PRODUCT	SIZE	PIECE
1433-1	BATHROOM CURTAIN	1x2mt	30



#### CHIMNEY COVER

CODE	PRODUCT	BOX	PACKAGE
1333	Chimney Cover with 6 Corners / White	50	200



# ONESTAR<sup>®</sup>

## Dowel group



[www.atilimaluminyum.com.tr](http://www.atilimaluminyum.com.tr)



[info@atilimaluminyum.com.tr](mailto:info@atilimaluminyum.com.tr)



EKO



**ONESTAR**

**WIDE CAP DOWEL / BLACK - NAVY - WHITE**

CODE	PRODUCT	PACKAGE
2334	Q60*10*60 - 80 - 100 - 120 -140 - 160 - 180 - 200 mm	250

EKO



**ONESTAR**

**NARROW CAP DOWEL / BLACK - WHITE - NAVY BLUE**

CODE	PRODUCT	PACKAGE
2336	Q50*10*80mm - Q50*10*100mm	250

**ONESTAR**

**WIDE CAP DOWEL / BLUE - TRANSPARENT - YELLOW - ORANGE - GREEN - RED**

CODE	PRODUCT	PACKAGE
2335	Q60*10*60 - 80 - 100 - 120 -140 - 160 - 180 - 200 mm	250

**ONESTAR**

**NARROW CAP DOWEL / BLUE - TRANSPARENT - YELLOW - RED**

CODE	PRODUCT	PACKAGE
2337	Q50*10*80mm - Q50*10*100mm	250

**ONESTAR**

**EURO STEEL STUDDED DOWEL**

CODE	PRODUCT	PACKAGE
2338	Q60*8*60 - 80 - 95 - 115 - 135 - 155 mm	250

**ONESTAR**

**STEEL STUDDED DOWEL WITH EURO MECHANICAL NAILS**

CODE	PRODUCT	PACKAGE
2339	Q60*8*95 - 115 - 135 - 155 - 175 - 195 mm	250

**ONESTAR**

**EURO ROCK WOOL DOWEL**

CODE	PRODUCT	PACKAGE
2340	90*8*115 - 135 - 155 mm	250

**ONESTAR**

**EURO PLASTIC STUDDED DOWEL**

CODE	PRODUCT	PACKAGE
2341	Q60*8*60 - 80 - 95 - 115 - 135 - 155 mm	250

**ONESTAR**

**PLASTIC STUDDED DOWEL WITH EURO MECHANICAL NAILS**

CODE	PRODUCT	PACKAGE
2342	Q60*8*95 - 115 - 135 - 155	250

**ONESTAR**

**EURO SCREW DOWEL**

CODE	PRODUCT	PACKAGE
2343	Q60*8*115 - 135 - 155 - 180 - 200 - 220 - 240 - 260 - 280 - 300	250



**ONESTAR®**

**EURO MECHANICAL TAB SCREW DOWEL**

CODE	PRODUCT	PACKAGE	SACK
2344	Q60*8*95 - 115 - 135 - 155 - 175 - 195	250	25.000



**ONESTAR®**

**AERATED CONCRETE DOWEL STEEL STUDDED**

CODE	PRODUCT	BOX	PACKAGE
2345	Dowel 140 - 160 mm	250	7.500



**ONESTAR®**

**AERATED CONCRETE DOWEL WITH PLASTIC STUDS**

CODE	PRODUCT	PACKAGE	SACK
2346	Q60*8*140 - 160 mm	250	25.000



**ONESTAR®**

**HIGH ADHESION AERATED CONCRETE DOWEL**

CODE	PRODUCT	PACKAGE	SACK
2347	Q60*10*110 - 140 mm	250	25.000



**ONESTAR®**

**UNIVERSAL DOWEL WITH WIDE CAP**

CODE	PRODUCT	PACKAGE	SACK
2347	Q60*10*100 - 120 - 140 mm	250	25.000



**ONESTAR®**

**YALI PRINTING JAMB DOWEL WITH THE TITLE "T"**

CODE	PRODUCT	PACKAGE	SACK
2348	10 - 12 - 16 cm	250	25.000

90 mm



**ONESTAR®**

**EURO ROCK WOOL DOWEL STAMP**

CODE	PRODUCT	PACKAGE	SACK
2349	90 mm	250	25.000



**ONESTAR®**

**FLOODING ADJUSTMENT WEDGE**

CODE	PRODUCT	BOX	PACKAGE
2350	3 mm - 5mm - 8 mm - 10 mm	500	250



**ONESTAR®**

**METAL DOWEL**

CODE	PRODUCT	PIECE	
2351	METAL DOWEL 110 - 140 - 170 - 200 mm	500	12.500
2352	Plastic Head 110 - 140 - 170 - 200 mm	500	12.500



**ONESTAR®**

**DOWEL WITH GAS LIGHTER**

CODE	PRODUCT	PACKAGE	SACK
2353	60x30 - 60x40 - 60x50 - 60x60 - 60x70 - 60x80 - 6x90	500	25.000
2354	Expandet Ip 140 Ex Gas Pistol	500	12.000
2355	Expandet Fuecel Fuel Cell 68 ml	500	25.000



**ONESTAR®**

**CURTAIN WALL INSULATION DOWEL**

CODE	PRODUCT	PIECE	
2356	Suitable for 50 mm Rock Wool	500	12.500
2357	Suitable for 80 mm Rock Wool	500	12.500



**ONESTAR®**

**CURTAIN WALL INSULATION DOWEL**

CODE	PRODUCT	PIECE	
2358	DOWEL 10 cm*4 cm - 10 cm*5 cm 12 cm*6 cm - 12 cm*8 cm - 16 cm*10 cm	500	12.500
2359	Steel Studded 10 cm*4 cm - 10 cm*5 cm 12 cm*6 cm - 12 cm*8 cm - 16 cm*10 cm	500	12.500



**ONESTAR®**

**OSB AND EXTERIOR WALL CLADDING PLATE ANCHOR**

CODE	PRODUCT	PIECE	
2360	Q60*25 SCREWLESS	100	2.500
2361	Q60*25 - 40 - 50 - 60 - 70 - 80 - 90 - 100 mm SCREWLESS	100	2.500



**ONESTAR®**

**NAIL-LESS CONCRETE DOWEL WITH NAILS**

CODE	PRODUCT	PIECE	
2362	BLACK 50 - 70 - 90 - 110 - 130 - 150 mm	500	12.500
2363	YELLOW 50 - 70 - 90 - 110 - 130 - 150 - 170 - 190 mm	500	12.500



**ONESTAR®**

**CONCRETE DOWEL WITHOUT NAILS**

CODE	PRODUCT	PIECE	
2364	Q45*8*80mm - Q45*8*100mm	100	2.500



**ONESTAR®**

**COUNTERSINKING APPARATUS**

CODE	PRODUCT	PIECE	
2365	Countersinking Apparatus	10	2.500



**ONESTAR®**

**HERAPOR NAIL**

CODE	PRODUCT	BOX	PACKAGE
2366	Herapor Nail	500	250



**ONESTAR®**

**DRAINAGE PLATE PIN**

CODE	PRODUCT	BOX	PACKAGE
2367	60 mm Drainage Board Pin With Tape Sequin	500	250
2368	80 mm Drainage Board Pin With Tape Sequin		



### ONESTAR®

#### PLASTIC DOWELS

CODE	PRODUCT	PACKAGE	SACK
2369	Plastic Dowel 6mm	1.000	25.000
2370	Plastic Dowel 8mm	1.000	25.000
2371	Plastic Dowel 10mm	500	25.000
2372	Plastic Dowel 12mm	500	10.000
2373	Plastic Dowel 14mm	250	5.000



### ONESTAR®

#### MEGA AND STUDED DOWEL

CODE	PRODUCT	PACKAGE	SACK
2374	Studded Dowel	500	25.000
2375	Mega Dowel	500	25.000



### ONESTAR®

#### YELLOW ROCKET ANCHOR

CODE	PRODUCT	PIECE	PIECE
2376	Yellow Rocket Dowel / 8mm	500	12.500
2377	Yellow Rocket Dowel / 10 mm	500	12.500



### ONESTAR®

#### METAL - PLASTIC SCREW WASHER

CODE	PRODUCT	BOX	PACKAGE
2378	Plastic Screw Washer/4 mm × 15.30mm	1.000	75.000
2379	Metal Screw Washer/3mm × 16mm		25kg



### ONESTAR®

#### DRYWALL DOWEL WITH WINGS

CODE	PRODUCT	BOX	PACKAGE
2380	Finned Drywall Dowel Series/2mm	500	7.500
2381	Finned Drywall Dowel Series/3mm	500	7.500



### ONESTAR®

#### BRICK CAVITY DOWEL

CODE	PRODUCT	PACKAGE	SACK
2382	Brick Cavity Dowel / 8mm	500	25.000
2383	Brick Cavity Dowel / 10mm	500	12.000
2384	Brick Cavity Dowel / 12mm	500	25.000



### ONESTAR®

#### TURBOLET DOWEL

CODE	PRODUCT	PIECE	PIECE
2385	Turbolet Dowel 8mm	500	10.000
2386	Turbolet Dowel 10mm	500	10.000



### ONESTAR®

#### YTONG DOWEL

CODE	PRODUCT	PIECE	PIECE
2387	Ytong Dowel/ 8 mm	100	2.500
2388	Ytong Dowel/ 10mm	100	2.500



### ONESTAR

#### HEAVY DUTY ANCHOR (SIDING)

CODE	PRODUCT	BOX	PACKAGE
2389	10*80 - 100 - 120 - 140 - 160 mm	250	25.000



### ONESTAR

#### HEAVY DUTY ANCHOR (SIDING)

CODE	PRODUCT	BOX	PACKAGE
2390	8*60 - 80 - 100mm	250	25.000



### ONESTAR

#### ALL ROUND DOWEL

CODE	PRODUCT	PIECE	
2391	8*40 - With/ Without Screws	500	10.000



100 Pieces of Metal Screws  
100 Pieces of All-Round Dowels  
**SET**



### ONESTAR

#### RED ROCKET ANCHOR

CODE	PRODUCT	BOX	PACKAGE
2392	Red Rocket Dowel/ 8mm-50mm	200	10.000



### ONESTAR

#### ASPHALT CASING AND DELINATOR ANCHOR / BLACK - WHITE

CODE	PRODUCT	BOX	PACKAGE
2393	16 x 90	200	10.000



### ONESTAR

#### CURTAIN ACCESSORY SERIES

CODE	PRODUCT	BOX	PACKAGE
2394	Butterfly Final	1.000	50.000
2395	T Final	1.000	50.000



### ONESTAR

#### CURTAIN ACCESSORY SERIES

CODE	PRODUCT	BOX	PACKAGE
2396	Machine Strut Roulette	1.000	50.000
2397	Hand-Held Roulette	1.000	50.000
2398	Interlaced Roulette	1.000	50.000
2399	Locked Roulette	1.000	50.000



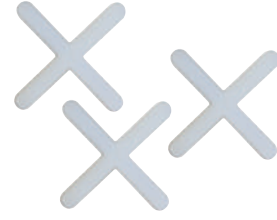
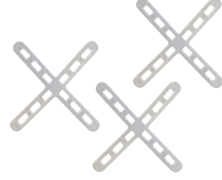

### ONESTAR

#### CORRUGATED JOINT PLUS

CODE	PRODUCT	PIECE
1404	3mm Corrugated Joint Plus	500

### ONESTAR

#### FLAT JOINT PLUS SERIES

CODE	PRODUCT	BOX	PACKAGE
1405	Flat Joint Extension /2mm	1.000	50.000
1406	Flat Joint Extension/3mm	1.000	50.000
1407	Flat Joint Extension/4mm	1.000	50.000
1408	Flat Joint Extension/5mm	1.000	50.000



### ONESTAR

#### MARBLE LEVEL DETECTION

CODE	PRODUCT	PIECE
1402	Marble Level Detection	100



### ONESTAR

#### LEVEL DETECTION PLIERS

CODE	PRODUCT	PIECE
1403	Level Detection Pliers	1

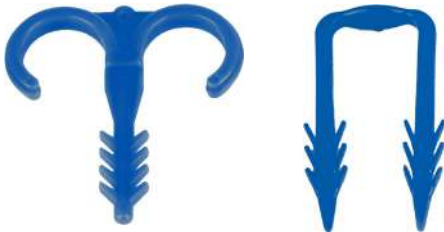

### ONESTAR

#### LOCATION DETECTION-PIPE DETECTION HOOK

CODE	PRODUCT	PIECE
1409	Location Detection Hook(Bone Hook)	250
1410	Pipe Fixing Hook	500

### ONESTAR

#### PIPE TURNING ELBOW

CODE	PRODUCT	PIECE
1411	Pipe Turning Elbow	10



## ONESTAR®

### LEVEL DETECTION EXTENSION

CODE	PRODUCT	PIECE
1400	Level Detection Extension 1 - 1,5 - 2 - 3 mm	100-200

## ONESTAR®

### LEVEL DETECTION WEDGE

CODE	PRODUCT	PIECE
1401	Leveling Wedge	100



**OUR WEBSITE**  
www.onestar.com.tr

**Placement test/ Class advantage**



**ONE7TOOLS**

**PVC Road Sign**

CODE	PRODUCT	BOX	PACKAGE
1412	PVC Road Sign	50	300



**ONE7TOOLS**

**CLASSIC SPEED BUMP COVER**

CODE	PRODUCT	BOX	PACKAGE
1413	CLASSIC SPEED BUMP COVER	50	300

**ONE7TOOLS**

**CLASSIC SPEED BUMP**

CODE	PRODUCT	BOX	PACKAGE
1414	CLASSIC SPEED BUMP COVER	50	300



**ONE7TOOLS**

**45CM DELINEATOR**

CODE	PRODUCT	BOX	PACKAGE
1415	45CM DELINEATOR	50	300

**ONE7TOOLS**

**75CM DELINEATOR**

CODE	PRODUCT	BOX	PACKAGE
1416	75CM DELINEATOR	50	300

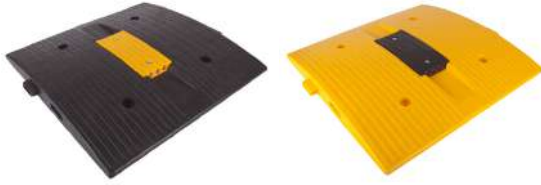

**ONE7TOOLS**

**OVAL SPEED BUMP CAT'S EYE**

CODE	PRODUCT	BOX	PACKAGE
1417	Oval Speed Bump with Cat's Eye	50	300



**ONE7TOOLS**

**OVAL SPEED BUMP COVER**

CODE	PRODUCT	BOX	PACKAGE
1418	OVAL SPEED BUMP COVER	50	300



**ONE7TOOLS**

**OVAL SPEED BUMP**

CODE	PRODUCT	BOX	PACKAGE
1419	Oval Speed Bump	50	300



**ONE7TOOLS**

**ROAD BARRIER**

CODE	PRODUCT	BOX	PACKAGE
1420	ROAD BARRIER	50	300



**ONE7TOOLS**

**PLASTIC ROAD BUTTON**

CODE	PRODUCT	BOX	PACKAGE
1421	PLASTIC ROAD BUTTON	50	300



**ONE7TOOLS**

**METAL ROAD BUTTON**

CODE	PRODUCT	BOX	PACKAGE
1422	METAL ROAD BUTTON	50	300



**ONE7TOOLS**

**TRAFFIC CONE 75CM**

CODE	PRODUCT	PACKAGE
1423	TRAFFIC CONE 75CM	50



**ONE7TOOLS**

**TRAFFIC CONE 45CM**

CODE	PRODUCT	PACKAGE
1424	TRAFFIC CONE 45CM	50



**ONE TOOLS**

**MULTI-PURPOSE WRENCH CURVED**

CODE	PRODUCT	BOX	-
1415	Curved Multi-Purpose Wrench	25	-



**ONE TOOLS**

**MULTI-PURPOSE WRENCH**

CODE	PRODUCT	BOX	-
1416	Multi-Tool	25	-

**ONE TOOLS**

**TYPES OF SCREWS**

CODE	PRODUCT
1416-1	Types of Screws







#### PAPER FUNNEL

CODE	PRODUCT	BOX	PACKAGE
1425	PAPER FUNNEL	-	-



#### DISINFECTANT

CODE	PRODUCT	BOX	PACKAGE
1426	DISINFECTANT 100ml	-	-
	DISINFECTANT 1000ml	-	-



#### TYPES OF SURGICAL MASKS

CODE	PRODUCT	BOX	PACKAGE
1427	Types of Masks	-	-



#### TYPES OF SURGICAL GLOVES

CODE	PRODUCT	BOX	PACKAGE
1428	Types of Gloves	-	-





#### CEILING U PROFILE

CODE	PRODUCT	SIZE	PIECE
1429	Ceiling U Profile	3mt	24



#### CEILING C PROFILE

CODE	PRODUCT	SIZE	PIECE
1430	Ceiling C Profile	3mt	12

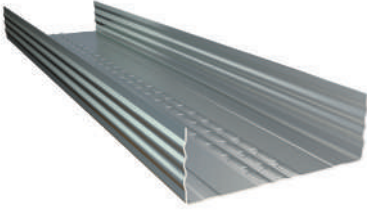

#### WALL U PROFILE

CODE	PRODUCT	SIZE	PIECE
1431	Wall U Profile	3mt	24

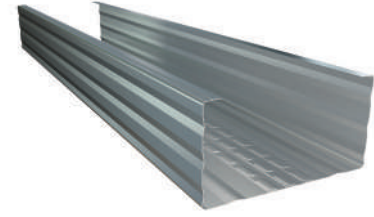

#### WALL C PROFILE

CODE	PRODUCT	SIZE	PIECE
1432	Wall C Profile	3mt	24

#### M PROFILE

CODE	PRODUCT	SIZE	PIECE
1433	M Profile	3mt	24

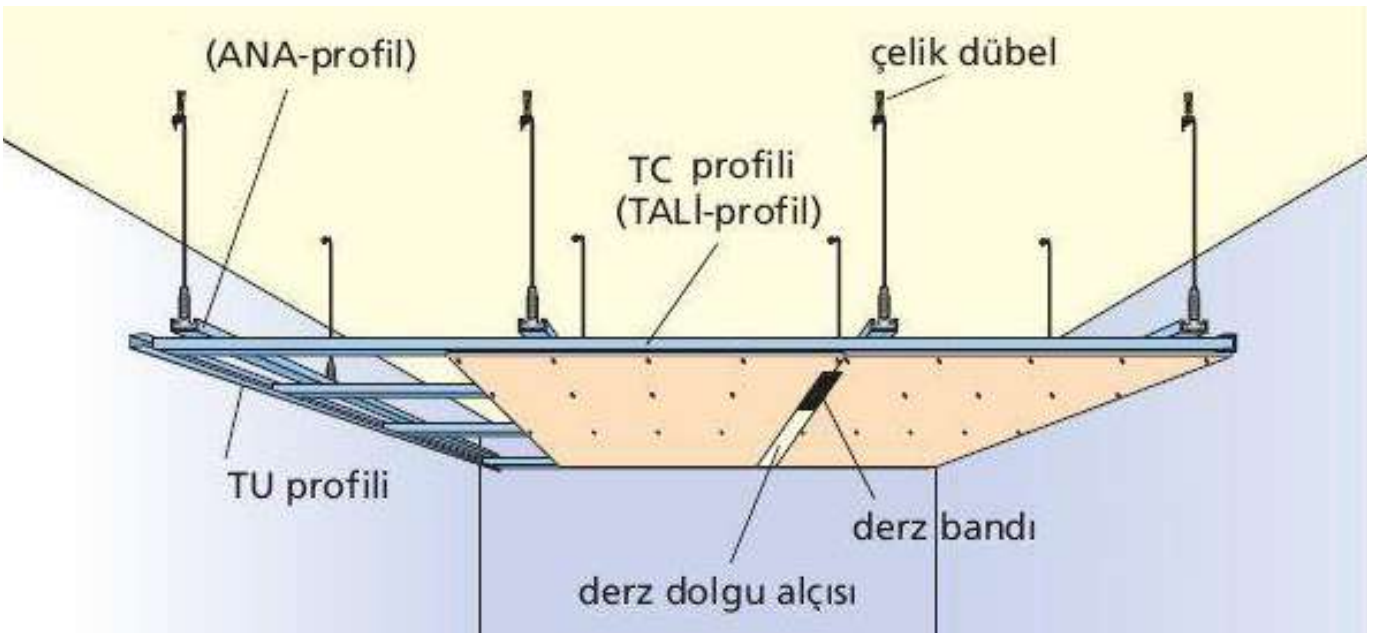
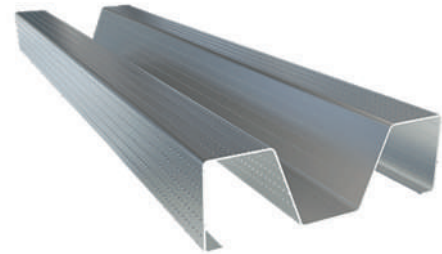



#### CLIP

CODE	PRODUCT	PIECE
1434	Clip	1000



#### HANGING TONGS (SPRING TONGS)

CODE	PRODUCT	PIECE
1435	Hanger Tongs	500



#### INSERTION PART

CODE	PRODUCT	PIECE
1436	Insertion Part	500



#### DOUBLE BOW

CODE	PRODUCT	PIECE
1437	Double Bow	1000



#### HANGING WIRE

CODE	PRODUCT	PIECE
1438	Hanging Wire 20cm	100
1439	Hanging Wire 30cm	100
1440	Hanging Wire 40cm	100
1441	Hanging Wire 50cm	100
1442	Hanging Wire 60cm	100
1443	Hanging Wire 80cm	100
1444	Hanging Wire 100cm	100
1445	Hanging Wire 120cm	100
1446	Hanging Wire 150cm	100
1447	Hanging Wire 200cm	100
1448	Hanging Wire 300cm	100

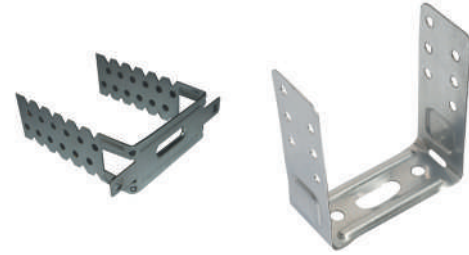

#### AGRAF

CODE	PRODUCT	PIECE
1449	Agraf 7cm	500
1450	Agraf 12cm	500
1451	Agraf 14cm	250
1452	Agraf 15cm	250
1453	Agraf 20cm	250
1454	Agraf 25cm	250
1455	Agraf 30cm	250
1456	Agraf 30cm - 1mm	250
1457	Agraf 40cm	200
1458	Agraf 40cm - 1mm	200
1459	Agraf 50cm - 1mm	50
1460	Agraf 60cm - 1mm	50



#### AERATED CONCRETE ANCHOR LAMAS

CODE	PRODUCT	PIECE
1461	Aerated Concrete Anchor Lamas	500



#### DETAIL U PROFILE (HIDDEN LIGHT BAND)

CODE	PRODUCT	SIZE	PIECE
1462	Detail U Profile	3mt	50



#### PLASTIC DOWEL

CODE	PRODUCT	PIECE
1463	Plastic Dowel 8mm	1000



#### PLASTERBOARD DOWEL

COD	PRODUCT	PIECE
1464	Plasterboard Dowel	1000



#### 22 45 FLAKE HEAD SCREW

CODE	PRODUCT	PIECE
1465	Clip	1000



#### SUSPENDED CEILING DOWEL 6x50

COD	PRODUCT	PIECE
1466	Suspended Ceiling Dowel 6x50	1000

#### ALUMINUM Z PROFILE

CODE	PRODUCT	SIZE	PIECE
1467	Z Profil 10mm	3mt	50
1468	Z Profil 15mm	3mt	50





#### CLIP-IN INSERT PART

CODE	PRODUCT	PIECE
1470	Clip-in Insert Part	1000



#### CLIP-İN TEL KLİPS

CODE	PRODUCT	PIECE
1471	Clip-in Tel Klips	3000



#### CLIP-ON SKI TABLE

CODE	PRODUCT	PIECE
1472	Clip-in Sling Tongs	1000



#### CLIP-İN PRINTING WEDGE

CODE	PRODUCT	PIECE
1473	Clip-in Printing Wedge	1000

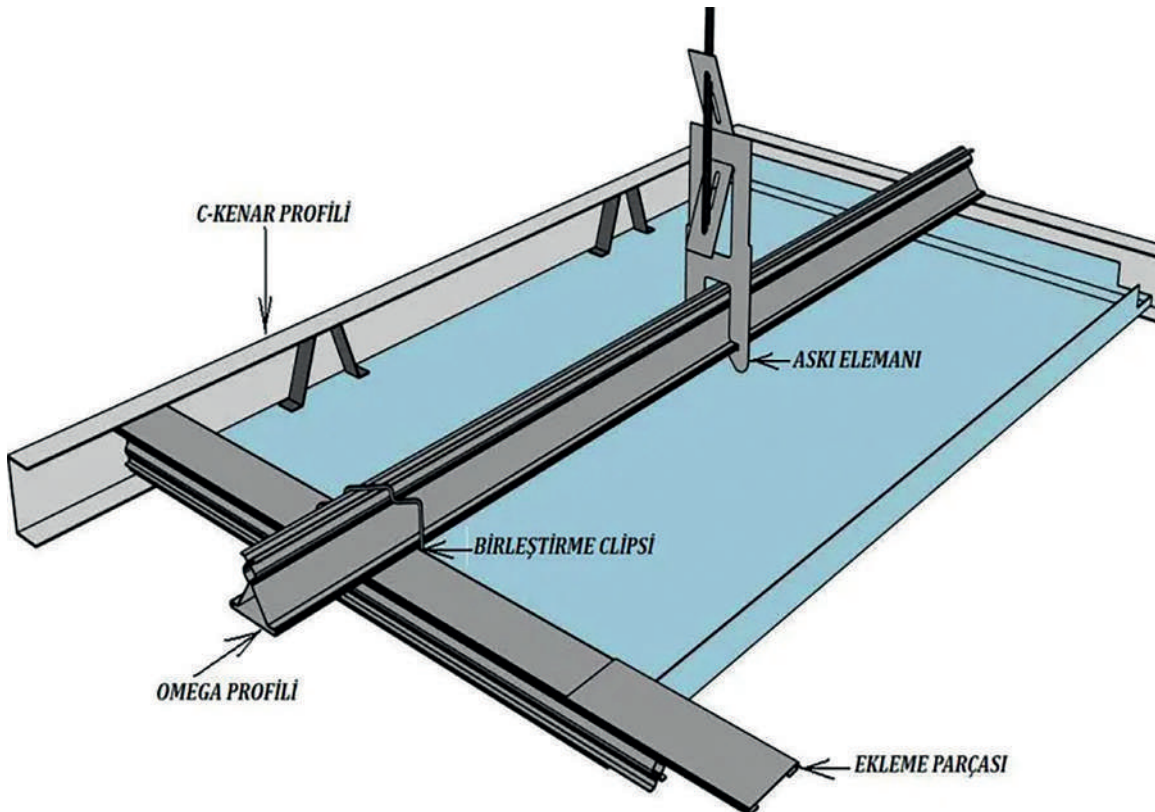





ONE TOOLS

**DOOR SAFETY APPARATUS**

CODE	PRODUCT	PIECE	-
1474	Door Safety Apparatus	1	-



ONE TOOLS

**GARDEN SHOVEL**

CODE	PRODUCT	PACKAGE	-
1475	Garden Shovel	1	-



ONE TOOLS

**PLASTIC RAKE**

CODE	PRODUCT	PACKAGE	-
1479	Plastic Rake	1	-



ONE TOOLS

**STALKED CUTS**

CODE	PRODUCT	PACKAGE	-
1477-1	Stalked Cuts	1	-



ONE TOOLS

**FLAT RAKE**

CODE	PRODUCT	PACKAGE	-
1476	FLAT RAKE 10 - 12 - 14 - 16 - 18 - 20 Diş	6	-



ONE TOOLS

**REINFORCED RAKE**

CODE	PRODUCT	PACKAGE	-
1477	Reinforced Rake 12 - 14 - 16 - 18 - 20 Diş	6	-



ONE TOOLS

**CONSTRUCTION REEL**

CODE	PRODUCT	PACKAGE	-
1478	Construction Reel 75 - 100 - 125 mm	12	-



ONE TOOLS

**PERGULE FOOT**

CODE	PRODUCT	PACKAGE	-
1482	Pergule Foot	20	-



**ONE**TOOLS

**LIGATURE SCISSORS**

CODE	PRODUCT	PACKAGE	-
1484	Ligature Scissors	1	-



**ONE**TOOLS

**HOBBY SET**

CODE	PRODUCT	PACKAGE	-
1485	Hobby Set	1	-



**ONE**TOOLS

**POINTED ANCHOR**

CODE	PRODUCT	PACKAGE	-
1486	Pointed Anchor	1	-



**ONE**TOOLS

**FORK ANCHOR**

CODE	PRODUCT	PACKAGE	-
1487	Fork Anchor	1	-

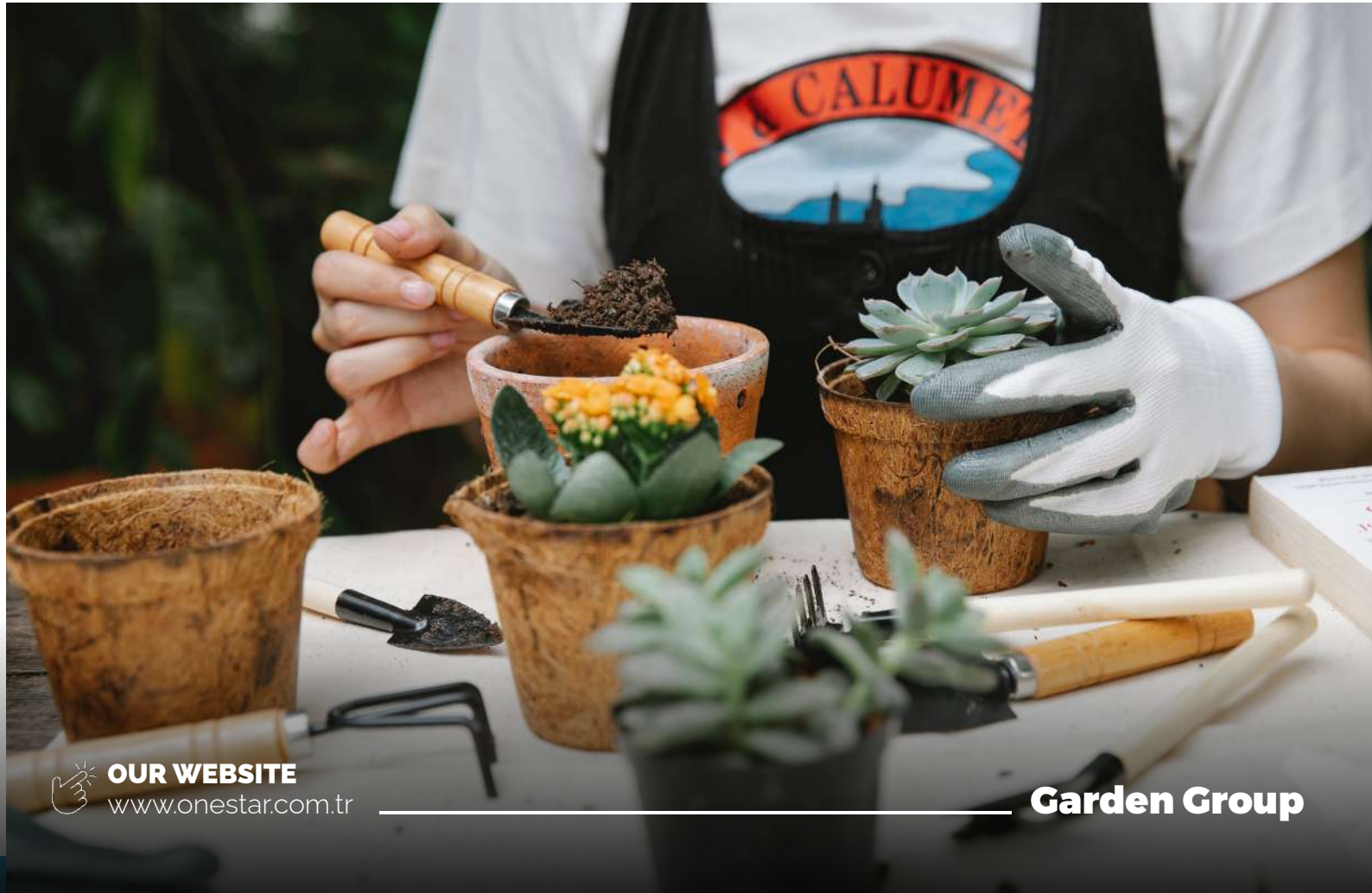

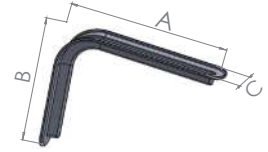

### LÜX RAF ALTI BEYAZ VE SİYAH

LUX SHELF BRACKETS WHITE AND BLACK

ONE TOOLS

Kod Code	No No	Kutu Miktarı Pack Quantity	Koli Miktarı Box Quantity
AA301	5x6	2 Düzine / Dozen	20 Düzine / Dozen
AA302	6x8	2 Düzine / Dozen	20 Düzine / Dozen
AA303	7x9	2 Düzine / Dozen	20 Düzine / Dozen
AA304	8x10	2 Düzine / Dozen	20 Düzine / Dozen
AA305	10x12	2 Düzine / Dozen	20 Düzine / Dozen
AA306	12x14	2 Düzine / Dozen	10 Düzine / Dozen

CODE	A	B	C	Sheet Thickness
BA301	140	110	36	0,80
BA302	200	135	36	0,80
BA303	230	165	36	0,80
BA304	260	190	36	0,80
BA305	290	230	36	0,80
BA306	330	260	36	1,00

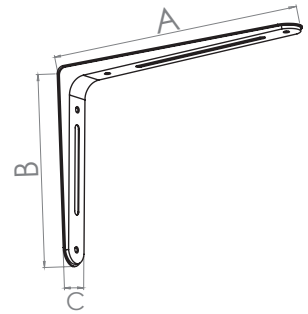

### KLAS RAF ALTI BEYAZ

CLASS SHELF BRACKETS / WHITE

ONE TOOLS

Kod Code	No No	Kutu Miktarı Pack Quantity	Koli Miktarı Box Quantity
AA331	1	2 Düzine / Dozen	20 Düzine / Dozen
AA332	2	2 Düzine / Dozen	20 Düzine / Dozen
AA333	3	2 Düzine / Dozen	20 Düzine / Dozen
AA334	4	2 Düzine / Dozen	20 Düzine / Dozen

CODE	A	B	C
BA 331	170	120	38
BA 332	220	160	38
BA 333	270	190	38
BA 334	315	220	38



**FERFORJE RAF ALTI**  
FORGED SHELF BRACKETS

**ONE TOOLS**

Kod Code	No No	Renk Color	Kutu Miktarı Pack Quantity	Koli Miktarı Box Quantity
AA341	1	Beyaz / White	20 Adet / Pcs	240 Adet / Pcs
AA341B	1	Bakır / Copper	20 Adet / Pcs	240 Adet / Pcs
AA341SY	1	Siyah / Black	20 Adet / Pcs	240 Adet / Pcs
AA342	2	Beyaz / White	20 Adet / Pcs	240 Adet / Pcs
AA342B	2	Bakır / Copper	20 Adet / Pcs	240 Adet / Pcs
AA342SY	2	Siyah / Black	20 Adet / Pcs	240 Adet / Pcs
AA343	3	Beyaz / White	20 Adet / Pcs	120 Adet / Pcs
AA343B	3	Bakır / Copper	20 Adet / Pcs	120 Adet / Pcs
AA343SY	3	Siyah / Black	20 Adet / Pcs	120 Adet / Pcs

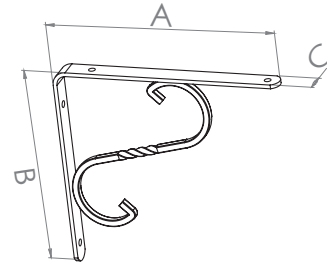

CODE	A	B	C
BA341	155	115	14
BA342	200	150	20
BA343	230	160	20



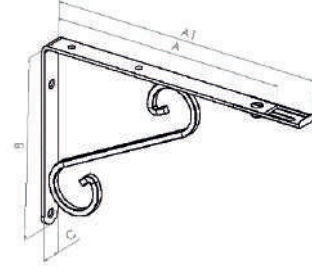

CODE	A	A1	B	C
BA311	153	180	112	14
BA312	200	250	150	20
BA313	235	290	160	20

### AYARLI RAF ALTI

ADJUSTABLE SHELF BRACKETS

**ONE TOOLS**

Kod Code	No No	Renk Color	Kutu Miktarı Pack Quantity	Koli Miktarı Box Quantity
AA311	1	Beyaz / White	20 Adet / Pcs	240 Adet / Pcs
AA312	2	Beyaz / White	20 Adet / Pcs	240 Adet / Pcs
AA313	3	Beyaz / White	20 Adet / Pcs	120 Adet / Pcs

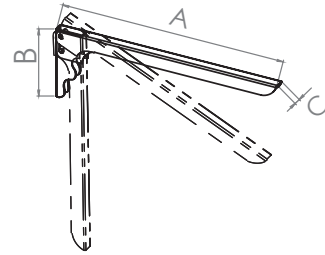

CODE	A	B	C
BA321KD	180	100	18
BA322KD	280	100	18

### KATLANIR RAF ALTI

FOLDING SHELF BRACKETS

**ONE TOOLS**

Kod Code	No No	Renk Color	Kutu Miktarı Pack Quantity	Koli Miktarı Box Quantity
AA321	1	Kadmiyum Cadmium	12 Adet / Pcs	120 Adet / Pcs
AA322	2	Kadmiyum Cadmium	12 Adet / Pcs	120 Adet / Pcs





### KAPI EMNİYET ZİNCİRİ

DOOR SAFETY CHAIN

**ONE**TOOLS

Kod Code	Renk Color	Kutu Miktarı Pack Quantity	Koli Miktarı Box Quantity
AA120 S	Sarı / Yellow	20 Adet / Pcs	100 Adet / Pcs
AA120 K	Krom / Chrome	20 Adet / Pcs	100 Adet / Pcs
AA120 ST	Saten / Satin	20 Adet / Pcs	100 Adet / Pcs



200Gram

\* Blister Packaging



### EMNİYET KELEPÇESİ

SAFETY CLAMP

**ONE**TOOLS

Kod Code	Renk Color	Kutu Miktarı Pack Quantity	Koli Miktarı Box Quantity
AA130 S	Sarı / Yellow	20 Adet / Pcs	100 Adet / Pcs
AA130 K	Krom / Chrome	20 Adet / Pcs	100 Adet / Pcs
AA130 ST	Saten / Satin	20 Adet / Pcs	100 Adet / Pcs



**YAYLI MENTEŞE SARI**  
DOUBLE ACTING SPRING HINGES YELLOW

**ONE**TOOLS

Kod Code	No No	Renk Color	Kutu Miktarı Pack Quantity	Koli Miktarı Box Quantity
AA60029S	29	Sarı / Yellow	1 Çift / 1 Pair	30 Çift / 30 Pair
AA60030S	30	Sarı / Yellow	1 Çift / 1 Pair	30 Çift / 30 Pair
AA60033S	33	Sarı / Yellow	1 Çift / 1 Pair	24 Çift / 24 Pair
AA60036S	36	Sarı / Yellow	1 Çift / 1 Pair	12 Çift / 12 Pair

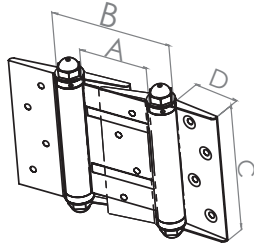
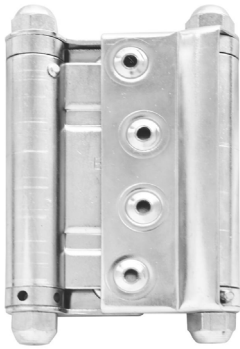

CODE	A	B	C	D
BA60029	33	73	75	23
BA60030	39	79	100	26
BA60033	46	90	123	29
BA60036	52	102	150	41

**YAYLI MENTEŞE NİKEL**  
DOUBLE ACTING SPRING HINGES NICKEL

**ONE**TOOLS

Kod Code	No No	Renk Color	Kutu Miktarı Pack Quantity	Koli Miktarı Box Quantity
AA60029N	29	Nikel / Nickel	1 Çift / 1 Pair	30 Çift / 30 Pair
AA60030N	30	Nikel / Nickel	1 Çift / 1 Pair	30 Çift / 30 Pair
AA60033N	33	Nikel / Nickel	1 Çift / 1 Pair	24 Çift / 24 Pair
AA60036N	36	Nikel / Nickel	1 Çift / 1 Pair	12 Çift / 12 Pair

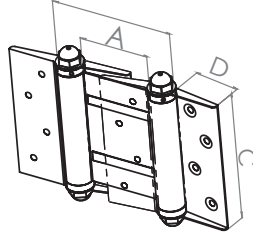

CODE	A	B	C	D
BA60029	33	73	75	23
BA60030	39	79	100	26
BA60033	46	90	123	29
BA60036	52	102	150	41

### YAYLI MENTEŞE SATEN

DOUBLE ACTING SPRING HINGES SATIN

**ONE TOOLS**

Kod Code	No No	Renk Color	Kutu Miktarı Pack Quantity	Koli Miktarı Box Quantity
AA60029ST	29	Saten / Satin	1 Çift / 1 Pair	30 Çift / 30 Pair
AA60030ST	30	Saten / Satin	1 Çift / 1 Pair	30 Çift / 30 Pair
AA60033ST	33	Saten / Satin	1 Çift / 1 Pair	24 Çift / 24 Pair
AA60036ST	36	Saten / Satin	1 Çift / 1 Pair	12 Çift / 12 Pair



### YAYLI MENTEŞE KADMIYUM

DOUBLE ACTING SPRING HINGES CADMIUM

**ONE TOOLS**

Kod Code	No No	Renk Color	Kutu Miktarı Pack Quantity	Koli Miktarı Box Quantity
AA60029KD	29	Kadmiyum / Cadmium	1 Çift / 1 Pair	30 Çift / 30 Pair
AA60030KD	30	Kadmiyum / Cadmium	1 Çift / 1 Pair	30 Çift / 30 Pair
AA60033KD	33	Kadmiyum / Cadmium	1 Çift / 1 Pair	24 Çift / 24 Pair
AA60036KD	36	Kadmiyum / Cadmium	1 Çift / 1 Pair	12 Çift / 12 Pair



### KAPI İTME YAYI

DOOR CLOSER

**ONE TOOLS**

Kod Code	Renk Color	Kutu Miktarı Pack Quantity	Koli Miktarı Box Quantity
AA650	Kadmiyum / Cadmium	1 Adet / 1 Pcs	40 Adet / 40 Adet

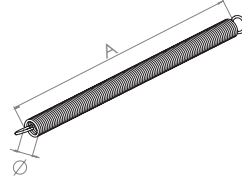
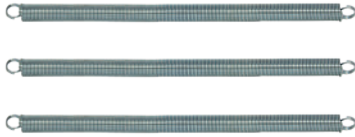

CODE	A	ø	WIRE DIAMETER
BA660	250	11	1,50
BA661	250	13	1,50
BA662	250	15	1,50

### TEL KAPI YAYI

WIRE DOOR SPRINGS

**ONE TOOLS**

Kod Code	Model Type	Boyut Size	Kutu Miktarı Pack Quantity	Koli Miktarı Box Quantity
AA660	Küçük / Small	3/8"	1 Düzine / 1 Dozen	25 Düzine / 25 Dozen
AA661	Orta / Medium	1/2"	1 Düzine / 1 Dozen	25 Düzine / 25 Dozen
AA662	Büyük / Large	5/8"	1 Düzine / 1 Dozen	25 Düzine / 25 Dozen

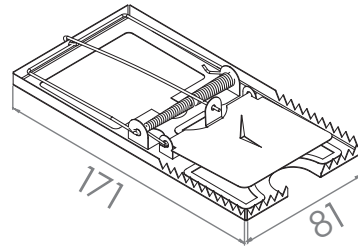
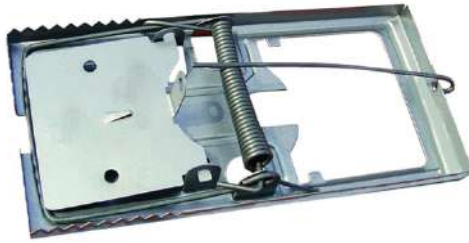

### FARE KAPANI

MOUSETRAP

**ONE TOOLS**

Kod Code	Renk Color	Kutu Miktarı Pack Quantity	Koli Miktarı Box Quantity
AA500	Siyah / Black	1 Düzine / Dozen	40 Düzine / Dozen

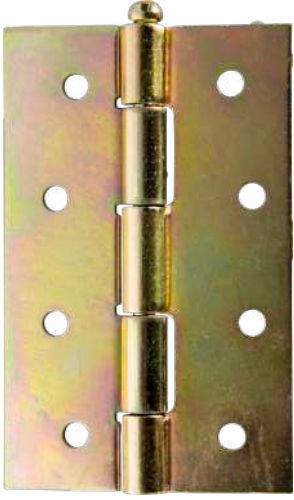

\* Only for these product  
1 Dozen = 24 Pcs  
\* Sadece bu ürün için  
1 Düzine = 24 Adet



### YAPRAK MENTEŞE

LEAF HINGE

ONE TOOLS

Kod Code	Model Type	Kutu Miktarı Pack Quantity	Koli Miktarı Box Quantity
AA62	2	1 Düzine / Dozen	48 Düzine / Dozen
AA63	3	1 Düzine / Dozen	36 Düzine / Dozen
AA64	4	1/2 Düzine / Dozen	12 Düzine / Dozen
AA65	5	1/2 Düzine / Dozen	10 Düzine / Dozen

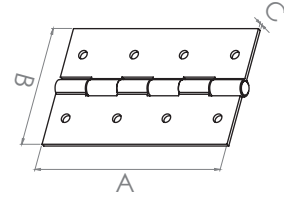

CODE	A	B	Thickness
BA62	50	34	0,80
BA63	74	47	1
BA64	100	61	2
BA65	112	68	2



## LEAF HINGE

### ROTA YAPRAK MENTEŞE

ROTA LEAF HINGE

ONE TOOLS

Kod Code	Model Type	Kutu Miktarı Pack Quantity	Koli Miktarı Box Quantity
AA20	2	1 Düzine / Dozen	48 Düzine / Dozen
AA25	2,5	1 Düzine / Dozen	36 Düzine / Dozen
AA30	3	1 Düzine / Dozen	36 Düzine / Dozen
AA35	3,5	1 Düzine / Dozen	24 Düzine / Dozen
AA40	4	1/2 Düzine / Dozen	12 Düzine / Dozen
AA50	5	1/2 Düzine / Dozen	10 Düzine / Dozen

CODE	A	B	Thickness
YM20	50	34	0,80
YM25	60	38	0,80
YM30	74	47	1
YM35	87	54	1
YM40	100	61	1,50
YM50	112	68	1,80



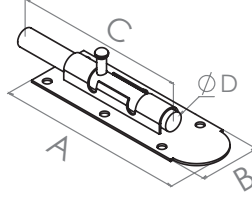
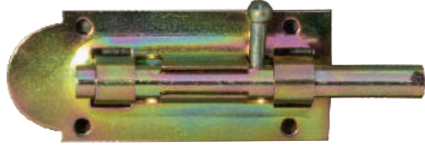

CODE	A	B	C	D
BA2002	69	32	72	8
BA2004	83	34,50	90	9
BA2006	87	34,50	90	9
BA2008	96	34,50	99	9
BA20010	110	42	107	9
BA20012	120	42	107	9
BA20014	135	42	107	9

### MAVZER SÜRGÜ

MAUSER BARREL BOLTS

**ONE TOOLS**

Kod Code	No No	Model Type	Kutu Miktarı Pack Quantity	Koli Miktarı Box Quantity
AA2002	2	Mavzer / Mauser	1 Düzine / 1 Dozen	30 Düzine / Dozen
AA2004	4	Mavzer / Mauser	1 Düzine / 1 Dozen	24 Düzine / Dozen
AA2006	6	Mavzer / Mauser	1 Düzine / 1 Dozen	24 Düzine / Dozen
AA2008	8	Mavzer / Mauser	1 Düzine / 1 Dozen	24 Düzine / Dozen
AA20010	10	Mavzer / Mauser	1 Düzine / 1 Dozen	20 Düzine / Dozen
AA20012	12	Mavzer / Mauser	1 Düzine / 1 Dozen	20 Düzine / Dozen
AA20014	14	Mavzer / Mauser	1 Düzine / 1 Dozen	20 Düzine / Dozen



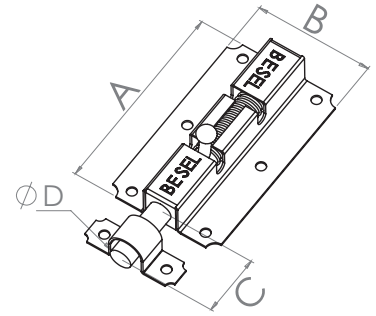
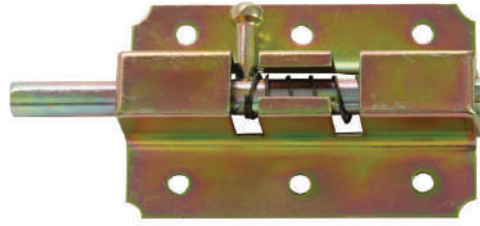

### YAYLI SÜRGÜ

SPRING BARREL BOLTS

**ONE**TOOLS

Kod Code	Model Type	Kutu Miktarı Pack Quantity	Koli Miktarı Box Quantity
AA225	Küçük / Small	1 Düzine / Dozen	30 Düzine / Dozen
AA220	Büyük / Large	1 Düzine / Dozen	20 Düzine / Dozen

CODE	A	B	C	øD
BA225	68	45	21	7
BA220	80	46	25	8

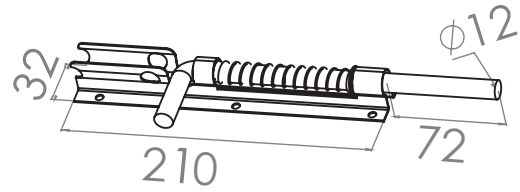
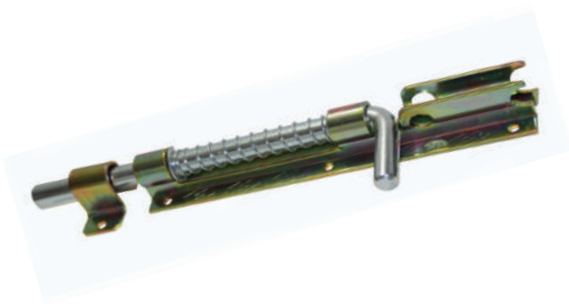

### FERFORJE SÜRGÜ

FORGED BOLTS

**ONE**TOOLS

Kod Code	Model Type	Renk Color	Kutu Miktarı Pack Quantity	Koli Miktarı Box Quantity
AA211	32x210mm	Kadmiyum / Cadmium	1 Adet / 1 Pcs	50 Adet / 50 Pcs

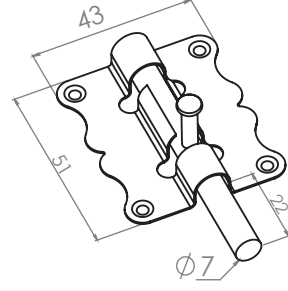
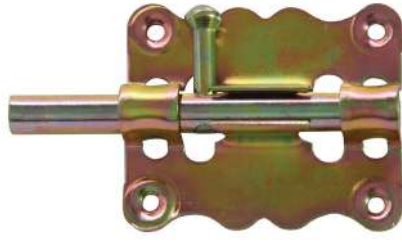

### KELEBEK SÜRGÜ

BUTTERFLY BARREL BOLTS

ONE TOOLS

Kod Code	Model Type	Kutu Miktarı Pack Quantity	Koli Miktarı Box Quantity
AA230	Kelebek / Butterfly	2 Düzine / Dozen	40 Düzine / Dozen

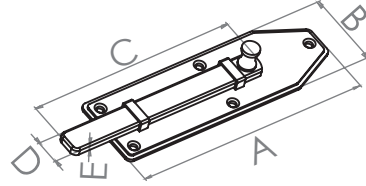

CODE	A	B	C	D	E
BA235	100	35	102	12	3,5

### SÜPER LÜKS SÜRGÜ

SUPER LUX BOLTS

ONE TOOLS

Kod Code	Model Type	Kutu Miktarı Pack Quantity	Koli Miktarı Box Quantity
AA235	Lüks / Lux	1 Düzine / Dozen	30 Düzine / Dozen

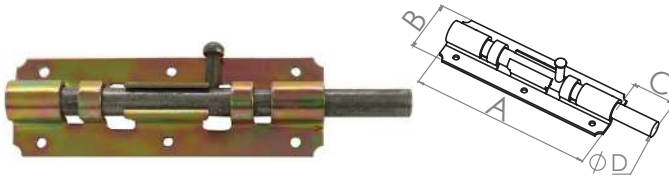

CODE	A	B	C	D
BA21016	85	39	30	11
BA21018	125	39	40	11

### DEMİR DOĞRAMA SÜRGÜLERİ

BARREL BOLTS FOR METAL

ONE TOOLS

Kod Code	No No	Model Type	Kutu Miktarı Pack Quantity	Koli Miktarı Box Quantity
AA21016	16	Demir Doğrama Iron Joinery	1 Düzine / 1 Dozen	16 Düzine / Dozen
AA21018	18	Delikli-Deliksiz Perforated Non Perforated	1 Düzine / 1 Dozen	12 Düzine / Dozen

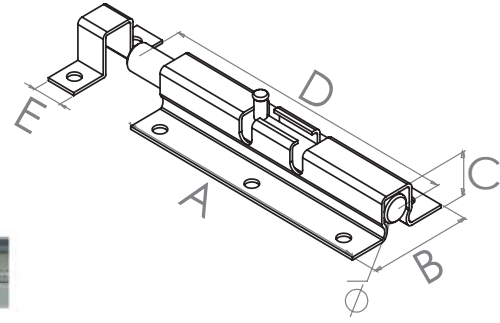
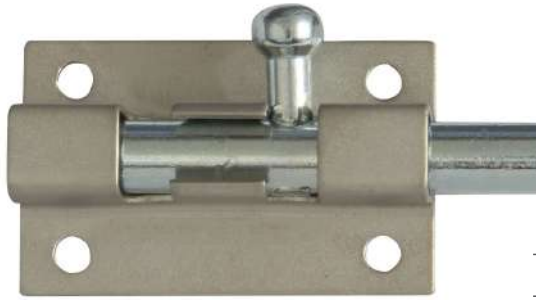

CODE	A	B	C	D	E	ø
BA244	40	25	12	54	10	7
BA247	70	25	12	84	10	7

### KLAS SÜRGÜLER

CLASS BARREL BOLTS

ONE TOOLS

Kod Code	Model Type	Renk Color	Kutu Miktarı Pack Quantity	Koli Miktarı Box Quantity
AA244S	40mm	Sarı / Yellow	2 Düzine / 2 Dozen	40 Düzine / Dozen
AA244K	40mm	Krom / Chrome	2 Düzine / 2 Dozen	40 Düzine / Dozen
AA244ST	40mm	Saten / Satin	2 Düzine / 2 Dozen	40 Düzine / Dozen
AA244	40mm	Beyaz / White	2 Düzine / 2 Dozen	40 Düzine / Dozen

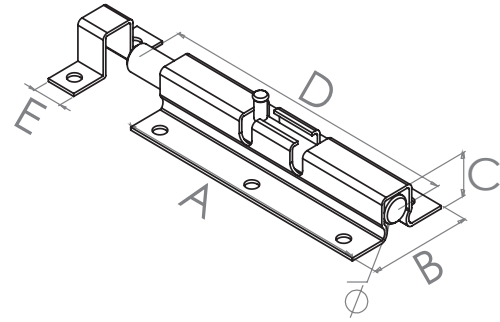
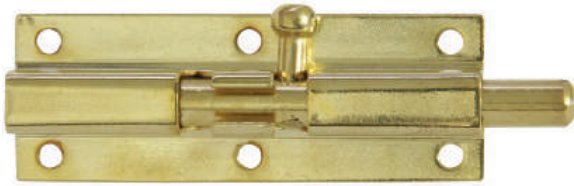

CODE	A	B	C	D	E	ø
BA244	40	25	12	54	10	7
BA247	70	25	12	84	10	7

### KLAS SÜRGÜLER

CLASS BARREL BOLTS

ONE TOOLS

Kod Code	Model Type	Renk Color	Kutu Miktarı Pack Quantity	Koli Miktarı Box Quantity
AA247S	70mm	Sarı / Yellow	1 Düzine / 1 Dozen	30 Düzine / Dozen
AA247K	70mm	Krom / Chrome	1 Düzine / 1 Dozen	30 Düzine / Dozen
AA247ST	70mm	Saten / Satin	1 Düzine / 1 Dozen	30 Düzine / Dozen
AA247	70mm	Beyaz / White	1 Düzine / 1 Dozen	30 Düzine / Dozen

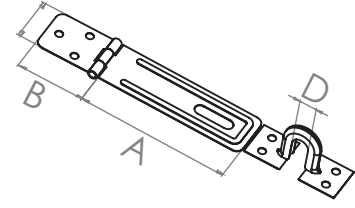

CODE	A	B	C	D
BA10025	59	27	25	10
BA10030	84	36	30	14
BA10035	110	41	35	14

### SANDIK ASKILARI

HASPS

ONE TOOLS

Kod Code	No No	Renk Color	Kutu Miktarı Pack Quantity	Koli Miktarı Box Quantity
AA10025	25	Kadmiyum / Cadmium	1 Düzine / 1 Dozen	50 Düzine / Dozen
AA10030	30	Kadmiyum / Cadmium	1 Düzine / 1 Dozen	40 Düzine / Dozen
AA10035	35	Kadmiyum / Cadmium	1 Düzine / 1 Dozen	40 Düzine / Dozen

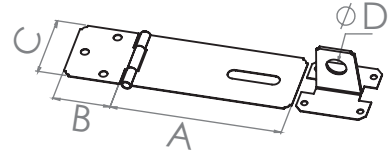

CODE	A	B	C	øD
BA11025	57	21	21	6,5
BA11030	75	24	30	10,5
BA11035	90	29	35	10,5

### LÜKS SANDIK ASKISI BAKIR BOYALI

LUX HASPS COPPER COATED

ONE TOOLS

Kod Code	No No	Renk Color	Kutu Miktarı Pack Quantity	Koli Miktarı Box Quantity
AA11025B	25	Bakır / Copper Coated	24 Adet / 24 Adet	576 Adet / 576 Adet
AA11030B	30	Bakır / Copper Coated	12 Adet / 12 Adet	384 Adet / 384 Adet
AA11035B	35	Bakır / Copper Coated	12 Adet / 12 Adet	288 Adet / 288 Adet

### LÜKS SANDIK ASKISI KROM KAPLAMA

LUX HASPS CHROME PLATING

ONE TOOLS

Kod Code	No No	Renk Color	Kutu Miktarı Pack Quantity	Koli Miktarı Box Quantity
AA11025K	25	Krom / Chrome Plating	24 Adet / 24 Adet	576 Adet / 576 Adet
AA11030K	30	Krom / Chrome Plating	12 Adet / 12 Adet	384 Adet / 384 Adet
AA11035K	35	Krom / Chrome Plating	12 Adet / 12 Adet	288 Adet / 288 Adet



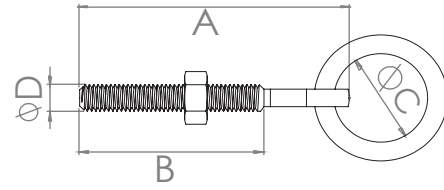

CODE	A	B	C	D
BA906	78	45	30	M6
BA908	69	50	32	M8
BA9010	95	65	35	M10

### HALKALI CİVATALAR

RING BOLTS

ONE TOOLS

Kod Code	Cins Kind	Kutu Miktarı Pack Quantity	Koli Miktarı Box Quantity
AA906	Halkalı Civata / Ring Bolt M6	60 Adet / 60 Pcs	480 Adet / Pcs
AA908	Halkalı Civata / Ring Bolt M8	60 Adet / 60 Pcs	480 Adet / Pcs
AA9010	Halkalı Civata / Ring Bolt M10	35 Adet / 35 Pcs	280 Adet / Pcs

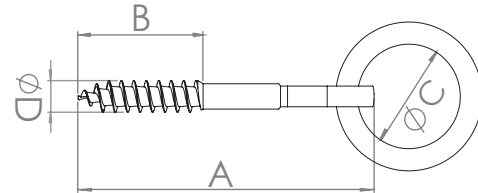

CODE	A	B	C	D
BA916	62	37	30	6
BA918	70	50	32	8
BA9110	95	50	35	10

### HALKALI VİDALAR

RING SCREWS

ONE TOOLS

Kod Code	Cins Kind	Kutu Miktarı Pack Quantity	Koli Miktarı Box Quantity
AA916	Halkalı Vida / Ring Screw 6mm	60 Adet / 60 Pcs	480 Adet / Pcs
AA918	Halkalı Vida / Ring Screw 8mm	60 Adet / 60 Pcs	480 Adet / Pcs
AA9110	Halkalı Vida / Ring Screw 10mm	35 Adet / 30 Pcs	280 Adet / Pcs

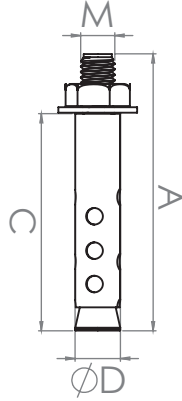

CODE	A	M	C	D
ÇD650	50	M6	32	8
ÇD665	65	M6	47	8
ÇD855	55	M8	38	10
ÇD875	75	M8	55	10
ÇD1075	75	M10	55	12
ÇD1085	85	M10	65	12
ÇD1290	90	M12	65	16
ÇD12110	110	M12	80	16

### ÇELİK DÜBEL GÖMLEKLİ STEEL ANCHOR

**ONE**TOOLS

Kod Code	Boyut Dimension	Kutu Miktarı Pack Quantity	Koli Miktarı Box Quantity
AAÇD650	M6X50	150 Adet / Pcs	1200 Adet / Pcs
AAÇD665	M6X65	150 Adet / Pcs	1200 Adet / Pcs
AAÇD855	M8X55	125 Adet / Pcs	1000 Adet / Pcs
AAÇD875	M8X75	125 Adet / Pcs	1000 Adet / Pcs
AAÇD1075	M10X75	60 Adet / Pcs	480 Adet / Pcs
AAÇD1085	M10X85	60 Adet / Pcs	480 Adet / Pcs
AAÇD1290	M12X90	35 Adet / Pcs	280 Adet / Pcs
AAÇD12110	M12X110	35 Adet / Pcs	280 Adet / Pcs

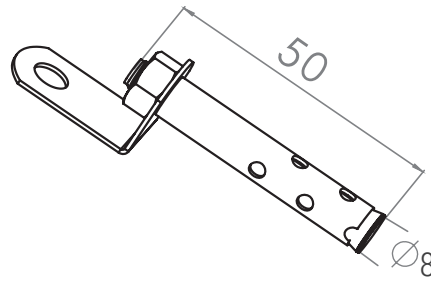

### ASMA TAVAN DÜBELİ SUSPENDED ANCHOR

**ONE**TOOLS

Kod Code	Boyut Dimension	Kutu Miktarı Pack Quantity	Koli Miktarı Box Quantity
AATD650	M6X50	125 Adet / Pcs	1000 Adet / Pcs

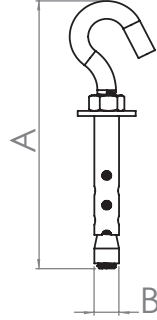

CODE	A	B	C
KD6	90	8	M6
KD8	100	10	M8
KD10	120	12	M10

### KANCALI DÜBEL AÇIK

HOOK ANCHOR OPEN

**ONE**TOOLS

Kod Code	Boyut Dimension	Kutu Miktarı Pack Quantity	Koli Miktarı Box Quantity
AAKD6	M6X90	125 Adet / Pcs	1000 Adet / Pcs
AAKD8	M8X100	60 Adet / Pcs	480 Adet / Pcs
AAKD10	M10X120	35 Adet / Pcs	280 Adet / Pcs

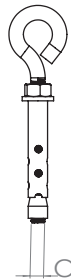

CODE	A	B	C
KD6K	90	8	M6
KD8K	100	10	M8
KD10K	120	12	M10

### KANCALI DÜBEL KAPALI

HOOK ANCHOR CLOSED

**ONE**TOOLS

Kod Code	Boyut Dimension	Kutu Miktarı Pack Quantity	Koli Miktarı Box Quantity
AAKD6K	M6X90	125 Adet / Pcs	1000 Adet / Pcs
AAKD8K	M8X100	60 Adet / Pcs	480 Adet / Pcs
AAKD10K	M10X120	35 Adet / Pcs	280 Adet / Pcs

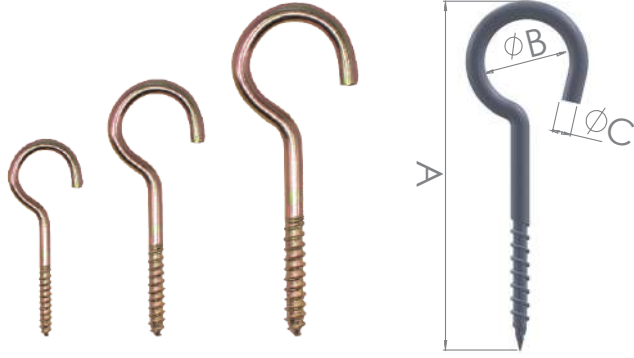

CODE	A	B	C
BA1630	29	7	2,50
BA1860	41	10	3,20
BA1970	47	12	3,60
BA2080	55	14	4,00
BA2180	68	16	4,20
BA21100	75	18	4,20
BA21200	130	18	4,20
BA22130	83	21	4,60
BA23150	92	22	5,20
BA24175	100	28	5,60
BA24200	124	28	5,60

### AÇIK PİTONLAR

OPEN EYE SCREWS

ONE TOOLS

Kod Code	Boyut Dimension	Kutu Miktarı Pack Quantity	Koli Miktarı Box Quantity
AA1630	16x30	200 Adet / Pcs	4000 Adet / Pcs
AA1860	18x60	100 Adet / Pcs	4000 Adet / Pcs
AA1970	19x70	100 Adet / Pcs	3000 Adet / Pcs
AA2080	20x80	100 Adet / Pcs	3000 Adet / Pcs
AA2180	21x80	100 Adet / Pcs	2400 Adet / Pcs
AA21100	21x100	100 Adet / Pcs	2400 Adet / Pcs
AA21200	21x200	50 Adet / Pcs	600 Adet / Pcs
AA22130	22x130	100 Adet / Pcs	1200 Adet / Pcs
AA23150	23x150	100 Adet / Pcs	1200 Adet / Pcs
AA24175	24x175	50 Adet / Pcs	600 Adet / Pcs
AA24200	24x200	50 Adet / Pcs	600 Adet / Pcs





CODE	A	B	C
BA1630K	29	7	2,50
BA2080K	55	14	4,00
BA21100K	75	18	4,20
BA22130K	83	21	4,60

### KAPALI PİTONLAR

CLOSED EYE SCREWS

ONE TOOLS

Kod Code	Boyut Dimension	Kutu Miktarı Pack Quantity	Koli Miktarı Box Quantity
AA1630K	16x30	200 Adet / Pcs	4000 Adet / Pcs
AA2080K	20x80	100 Adet / Pcs	3000 Adet / Pcs
AA21100K	21x100	100 Adet / Pcs	2400 Adet / Pcs
AA22130K	22x130	100 Adet / Pcs	1200 Adet / Pcs

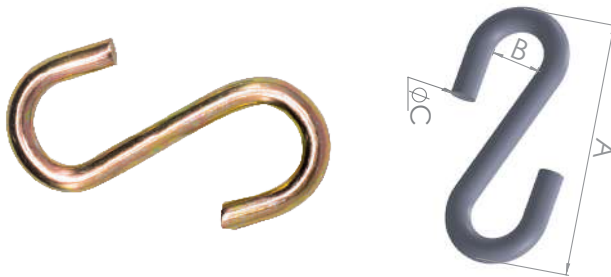
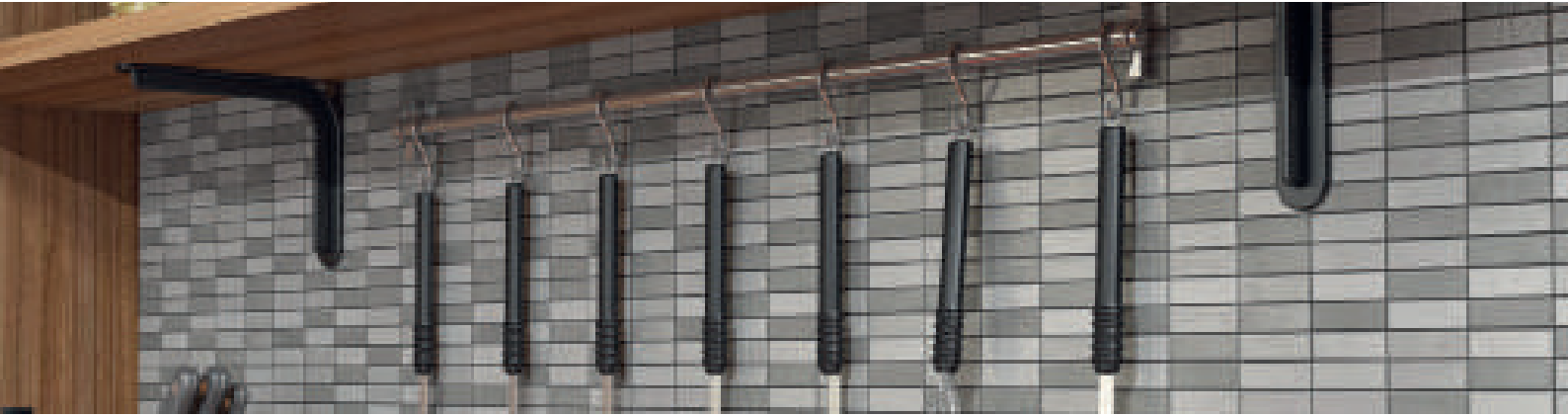

CODE	A	B	C
BA961	38	10	4
BA962	55	14	5

### "S" KANCALAR

"S" HOOKS

ONE TOOLS

Kod Code	Boyut Dimension	Kutu Miktarı Pack Quantity	Koli Miktarı Box Quantity
AA961	Küçük / Small	100 Adet / Pcs	3000 Adet / Pcs
AA962	Büyük / Large	100 Adet / Pcs	1200 Adet / Pcs



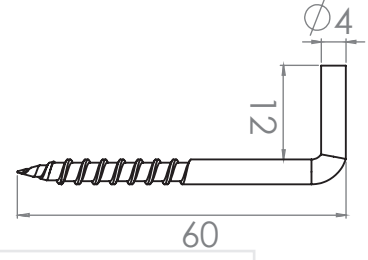

### KORNIŞ VİDASI

CORNICE SCREW

ONE TOOLS

Kod Code	Boyut Dimension	Kutu Miktarı Pack Quantity	Koli Miktarı Box Quantity
AA9246	4x60	100 Adet / Pcs	3000 Adet / Pcs

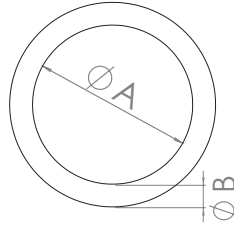

CODE	A	B
BA9514	28	3,50
BA9516	31	3,80
BA9518	35	4,40
BA9520	42	4,60

### HALKALAR

RINGS

ONE TOOLS

Kod Code	No No	Kutu Miktarı Pack Quantity	Koli Miktarı Box Quantity
AA9514	14	100 Adet / Pcs	2400 Adet / Pcs
AA9516	16	100 Adet / Pcs	2400 Adet / Pcs
AA9518	18	100 Adet / Pcs	1200 Adet / Pcs
AA9520	20	100 Adet / Pcs	1200 Adet / Pcs

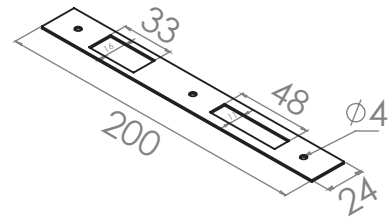

### DÜZ KİLİT KARŞILIĞI

STRIKE PLATE

ONE TOOLS

Kod Code	Renk Color	Kutu Miktarı Pack Quantity	Koli Miktarı Box Quantity
AA461ST	Saten / Satin	50 Adet / Pcs	500 Adet / Pcs
AA460KD	Kadmiyum / Cadmium	50 Adet / Pcs	500 Adet / Pcs

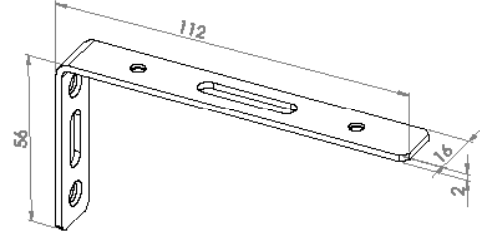

**KORNIŞ DEMİRİ**  
CURTAIN RAIL ANGLE

**ONE TOOLS**

Kod Code	No No	Kutu Miktarı Pack Quantity	Koli Miktarı Box Quantity
AA620	1	50 Adet / Pcs	500 Adet / Pcs

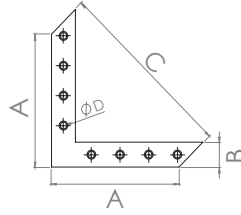
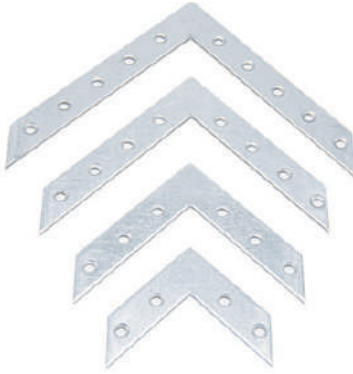

CODE	A	B	C	D
BA606	42	15	60	4
BA608	60	15	87	4
BA610	80	15	113	4
BA612	100	15	140	4

**KALIN SAÇ GÖNYE KAPLAMALI**  
FLAT CORNER BRACKETS

**ONE TOOLS**

Kod Code	No No	Kutu Miktarı Pack Quantity	Koli Miktarı Box Quantity
AA606	6	50 Adet / Pcs	1000 Adet / Pcs
AA608	8	50 Adet / Pcs	1000 Adet / Pcs
AA610	10	50 Adet / Pcs	500 Adet / Pcs
AA612	12	50 Adet / Pcs	500 Adet / Pcs



CODE	A	B	C
BA1525	25	25	15
BA1535	35	35	15
BA1545	45	45	15
BA1555	55	55	15
BA1565	65	65	15
BA1575	75	75	15

### MASA GÖNYE 15 SERİSİ

CORNER BRACKETS 15 SERIES

**ONE**TOOLS

Kod Code	Boyut Dimension	Kutu Miktarı Pack Quantity	Koli Miktarı Box Quantity
AA1525	15x25	150 Adet / Pcs	3000 Adet / Pcs
AA1535	15x35	100 Adet / Pcs	2000 Adet / Pcs
AA1545	15x45	75 Adet / Pcs	1500 Adet / Pcs
AA1555	15x55	100 Adet / Pcs	1000 Adet / Pcs
AA1565	15x65	75 Adet / Pcs	750 Adet / Pcs
AA1575	15x75	60 Adet / Pcs	600 Adet / Pcs

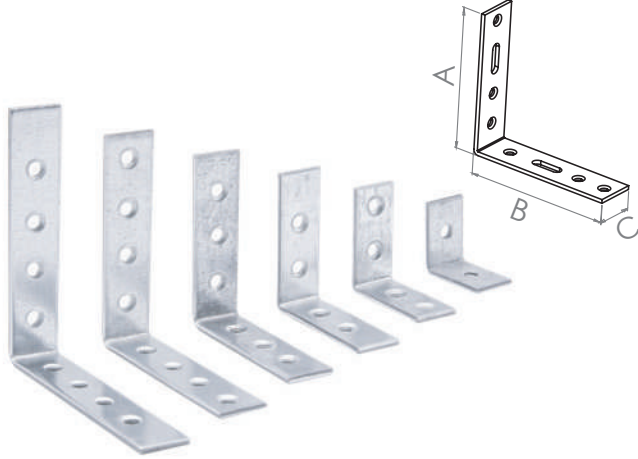

CODE	A	B	C
BA2025	25	25	20
BA2035	35	35	20
BA2045	45	45	20
BA2055	55	55	20
BA2065	65	65	20
BA2075	75	75	20

### MASA GÖNYE 20 SERİSİ

CORNER BRACKETS 20 SERIES

**ONE**TOOLS

Kod Code	Boyut Dimension	Kutu Miktarı Pack Quantity	Koli Miktarı Box Quantity
AA2025	20x25	100 Adet / Pcs	2000 Adet / Pcs
AA2035	20x35	70 Adet / Pcs	1400 Adet / Pcs
AA2045	20x45	50 Adet / Pcs	1000 Adet / Pcs
AA2055	20x55	70 Adet / Pcs	700 Adet / Pcs
AA2065	20x65	60 Adet / Pcs	600 Adet / Pcs
AA2075	20x75	50 Adet / Pcs	500 Adet / Pcs

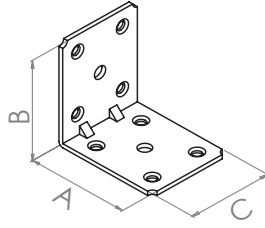

CODE	A	B	C
BA4030	30	30	40
BA4040	40	40	40
BA4050	50	50	40
BA4060	60	60	40
BA4080	80	80	40
BA40100	100	100	40

### MASA GÖNYE GENİŞ 40 SERİSİ

CORNER BRACKETS WIDE 40 SERIES

**ONE**TOOLS

Kod Code	Boyut Dimension	Kutu Miktarı Pack Quantity	Koli Miktarı Box Quantity
AA4030	40x30	50 Adet / Pcs	500 Adet / Pcs
AA4040	40x40	50 Adet / Pcs	500 Adet / Pcs
AA4050	40x50	50 Adet / Pcs	500 Adet / Pcs
AA4060	40x60	50 Adet / Pcs	500 Adet / Pcs
AA4080	40x80	25 Adet / Pcs	250 Adet / Pcs
AA40100	40x100	25 Adet / Pcs	250 Adet / Pcs

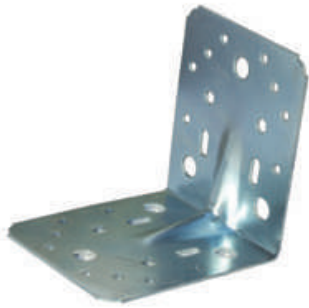

CODE	A	B	D
BA 5570	70	55	2 mm
BA 6590	90	65	2 mm
BA 90105	105	90	2 mm

### METAL KÖŞE BAĞLANTISI

METAL CORNER CONNECTION

**ONE**TOOLS

Kod Code	Boyut Dimension	Koli Miktarı Box Quantity
AA5570	55x70x70	150 Adet / Pcs
AA6590	65x90x90	100 Adet / Pcs
AA90105	90x105x105	60 Adet / Pcs

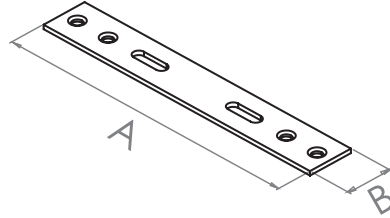
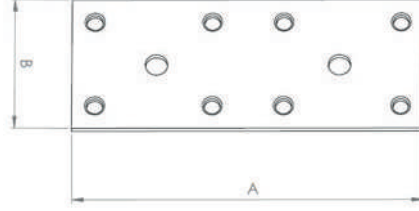

CODE	A	B
DB2070	70	20
DB2090	90	20
DB20110	110	20
DB20130	130	20
DB4060	60	40
DB4080	80	40
DB40100	100	40
DB40120	120	40
DB40160	160	40
DB40200	200	40
DB55140	140	55
DB65180	180	65
DB90210	210	90

## \*Sheet Thickness: 2.00mm

### DÜZ BAĞLANTILAR FLAT CONNECTOR

ONE TOOLS

Kod Code	No No	Kutu Miktarı Pack Quantity	Koli Miktarı Box Quantity
AADB2070	20x70	100 Adet / Pcs	1000 Adet / Pcs
AADB2090	20x90	100 Adet / Pcs	1000 Adet / Pcs
AADB20110	20x110	100 Adet / Pcs	1000 Adet / Pcs
AADB20130	20x130	100 Adet / Pcs	1000 Adet / Pcs
AADB4060	40x60	50 Adet / Pcs	500 Adet / Pcs
AADB4080	40x80	50 Adet / Pcs	500 Adet / Pcs
AADB40100	40x100	50 Adet / Pcs	500 Adet / Pcs
AADB40120	40x120	50 Adet / Pcs	500 Adet / Pcs
AADB40160	40x160	50 Adet / Pcs	250 Adet / Pcs
AADB40200	40x200	50 Adet / Pcs	250 Adet / Pcs
AADB55140	55x140	50 Adet / Pcs	50 Adet / Pcs
AADB65180	65x180	50 Adet / Pcs	50 Adet / Pcs
AADB90210	90x210	50 Adet / Pcs	50 Adet / Pcs



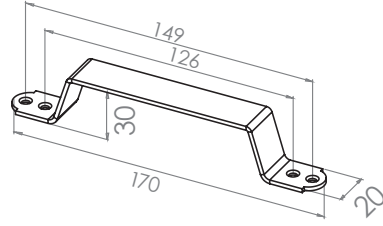

### DEMİR DOĞRAMA KULPLARI BÜYÜK

HANDLE METAL FURNITURE BIG

ONE TOOLS

Kod Code	Model Type	Renk Color	Kutu Miktarı Pack Quantity	Koli Miktarı Box Quantity
AA560S	Büyük / Big	Sarı / Yellow	2 Düzine / Dozen	40 Düzine / Dozen
AA560	Büyük / Big	Beyaz / White	2 Düzine / Dozen	40 Düzine / Dozen
AA560B	Büyük / Big	Bakır / Copper	2 Düzine / Dozen	40 Düzine / Dozen
AA560SY	Büyük / Big	Siyah / Black	2 Düzine / Dozen	40 Düzine / Dozen
AA560K	Büyük / Big	Krom / Chrome	2 Düzine / Dozen	40 Düzine / Dozen

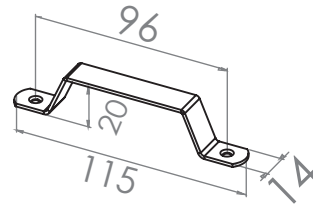

### DEMİR DOĞRAMA KULPLARI KÜÇÜK

HANDLE METAL FURNITURE SMALL

ONE TOOLS

Kod Code	Model Type	Renk Color	Kutu Miktarı Pack Quantity	Koli Miktarı Box Quantity
AA550S	Küçük / Small	Sarı / Yellow	2 Düzine / Dozen	40 Düzine / Dozen
AA550	Küçük / Small	Beyaz / White	2 Düzine / Dozen	40 Düzine / Dozen
AA550B	Küçük / Small	Bakır / Copper	2 Düzine / Dozen	40 Düzine / Dozen
AA550SY	Küçük / Small	Siyah / Black	2 Düzine / Dozen	40 Düzine / Dozen
AA550K	Küçük / Small	Krom / Chrome	2 Düzine / Dozen	40 Düzine / Dozen

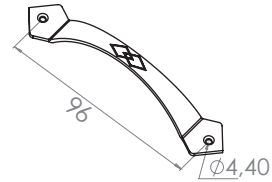

### MOBİLYA KULBU

FURNITURE HANDLE

ONE TOOLS

Kod Code	Boyut Dimension	Renk Color	Kutu Miktarı Pack Quantity	Koli Miktarı Box Quantity
AA570A	96 mm	Antik / Antique	50 Adet / Pcs	500 Adet / Pcs
AA570ST	96 mm	Saten / Satin	50 Adet / Pcs	500 Adet / Pcs
AA570K	96 mm	Krom / Chrome	50 Adet / Pcs	500 Adet / Pcs

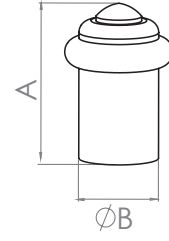

CODE	A	B
BA410S	39	20
BA410ST	39	20
BA410K	39	20
BA410US	54	20
BA410UST	54	20
BA410UK	54	20

### YER TAMPONLARI

FLOOR MOUNTING STOPPER

**ONE TOOLS**

Kod Code	Boyut Dimension	Renk Color	Kutu Miktarı Pack Quantity	Koli Miktarı Box Quantity
AA410S	35 mm	Sarı / Yellow	50 Adet / 50 Adet	500 Adet / 500 Adet
AA410ST	35 mm	Saten / Satin	50 Adet / 50 Adet	500 Adet / 500 Adet
AA410K	35 mm	Krom / Chrome	50 Adet / 50 Adet	500 Adet / 500 Adet
AA410US	50 mm	Sarı / Yellow	40 Adet / 40 Adet	400 Adet / 400 Adet
AA410UST	50 mm	Saten / Satin	40 Adet / 40 Adet	400 Adet / 400 Adet
AA410UK	50 mm	Krom / Chrome	40 Adet / 40 Adet	400 Adet / 400 Adet



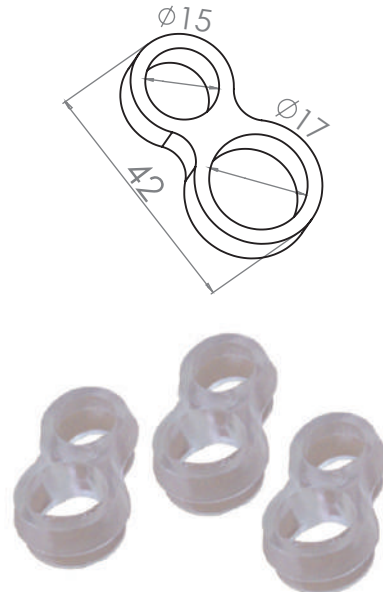

**KOL TAMPONU**  
DOOR HANDLE PAD

**ONE TOOLS**

Kod Code	Renk Color	Kutu Miktarı Pack Quantity	Koli Miktarı Box Quantity
AA700	Şeffaf / Transparent	100 Paket (1PKT=5ADT) 100 Packs (1PCK=5PCS)	500 Paket / Pck

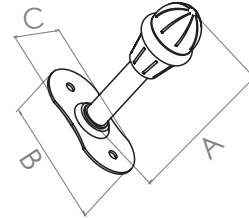

CODE	A	B	C
BA 400	78	30	30
BA 400S	78	30	30
BA 400K	78	30	30
BA 400ST	78	30	30

**KAPI TAMPONLARI**  
DOOR STOPPERS

**ONE TOOLS**

Kod Code	Renk Color	Kutu Miktarı Pack Quantity	Koli Miktarı Box Quantity
AA400S	Sarı / Yellow	50 Adet / Pcs	500 Adet / Pcs
AA400	Beyaz / White	50 Adet / Pcs	500 Adet / Pcs
AA400K	Krom / Chrome	50 Adet / Pcs	500 Adet / Pcs
AA400ST	Saten / Satin	50 Adet / Pcs	500 Adet / Pcs



**METAL VESTİYER ASKILARI SARIKLI**  
METAL HANGER HOOKS TURBANS

**ONE TOOLS**

Kod Code	Renk Color	Kutu Miktarı Pack Quantity	Koli Miktarı Box Quantity
AA800S	Sarı / Yellow	100 Adet / Pcs	1000 Adet / Pcs
AA800	Beyaz / White	100 Adet / Pcs	1000 Adet / Pcs
AA800K	Krom / Chrome	100 Adet / Pcs	1000 Adet / Pcs
AA800ST	Saten / Satin	100 Adet / Pcs	1000 Adet / Pcs
AA800A	Antik / Antique	100 Adet / Pcs	1000 Adet / Pcs
AA800B	Bakır / Copper	100 Adet / Pcs	1000 Adet / Pcs
AA800SY	Siyah / Black	100 Adet / Pcs	1000 Adet / Pcs



**METAL VESTİYER ASKILARI PAPATYA**  
METAL HANGER HOOKS DAISY

**ONE TOOLS**

Kod Code	Renk Color	Kutu Miktarı Pack Quantity	Koli Miktarı Box Quantity
AA810S	Sarı / Yellow	100 Adet / Pcs	1000 Adet / Pcs
AA810	Beyaz / White	100 Adet / Pcs	1000 Adet / Pcs
AA810K	Krom / Chrome	100 Adet / Pcs	1000 Adet / Pcs
AA810ST	Saten / Satin	100 Adet / Pcs	1000 Adet / Pcs
AA810A	Antik / Antique	100 Adet / Pcs	1000 Adet / Pcs
AA810B	Bakır / Copper	100 Adet / Pcs	1000 Adet / Pcs
AA810SY	Siyah / Black	100 Adet / Pcs	1000 Adet / Pcs

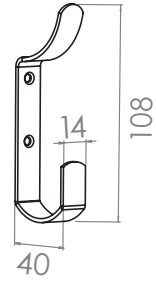

**ÇENGEL METAL ASKI**  
METAL HANGER HOOK

**ONE TOOLS**

Kod Code	Renk Color	Kutu Miktarı Pack Quantity	Koli Miktarı Box Quantity
AA860S	Sarı / Yellow	40 Adet / Pcs	400 Adet / Pcs
AA860	Beyaz / White	40 Adet / Pcs	400 Adet / Pcs
AA860K	Krom / Chrome	40 Adet / Pcs	400 Adet / Pcs
AA860ST	Saten / Satin	40 Adet / Pcs	400 Adet / Pcs
AA860B	Bakır / Copper	40 Adet / Pcs	400 Adet / Pcs
AA860SY	Siyah / Black	40 Adet / Pcs	400 Adet / Pcs





*Sector Experience*





**ATILIM ALÜMİNYUM**

**ALUMINUM FURNITURE PROFILE**

► HEIGHT HANDLE PROFILES

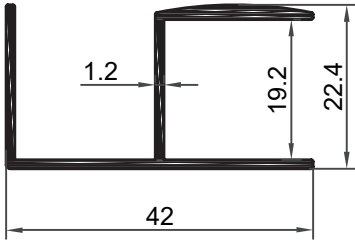

Kod / Code AA25981  
Kg / m 0,363

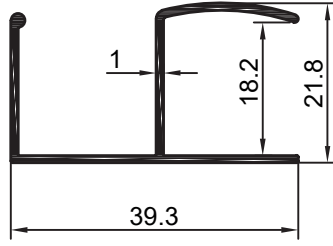

Kod / Code AA29644  
Kg / m 0,265

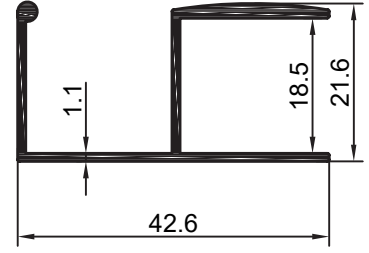

Kod / Code AA28041  
Kg / m 0,351

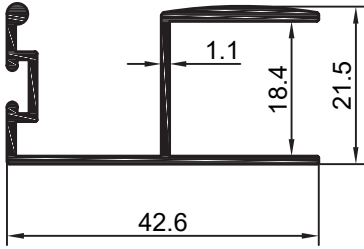

Kod / Code AA28107  
Kg / m 0,382

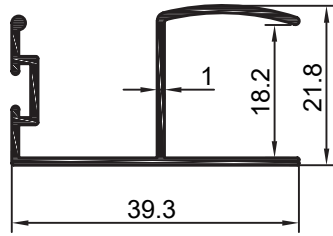

Kod / Code AA29861  
Kg / m 0,287

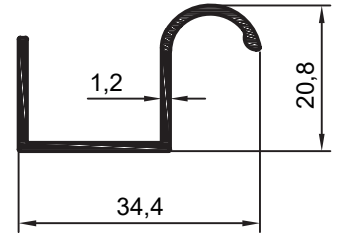

Kod / Code AA28497  
Kg / m 0,226

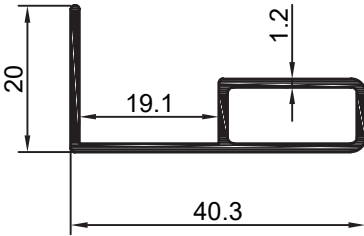

Kod / Code AA210696  
Kg / m 0,290

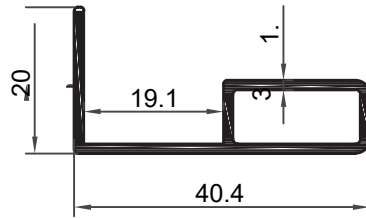

Kod / Code AA27967  
Kg / m 0,326

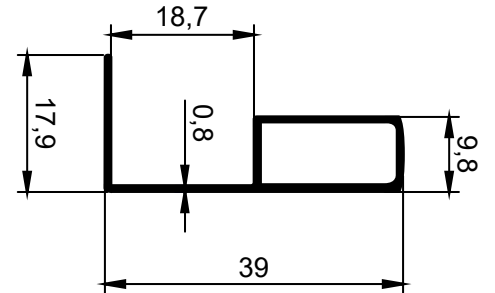

Kod / Code AA212080  
Kg / m 0,200



► HEIGHT HANDLE PROFILES

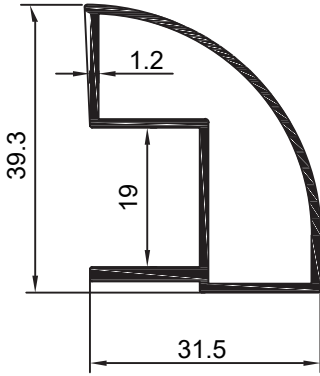

Kod / Code AA210642

Kg / m 0,482

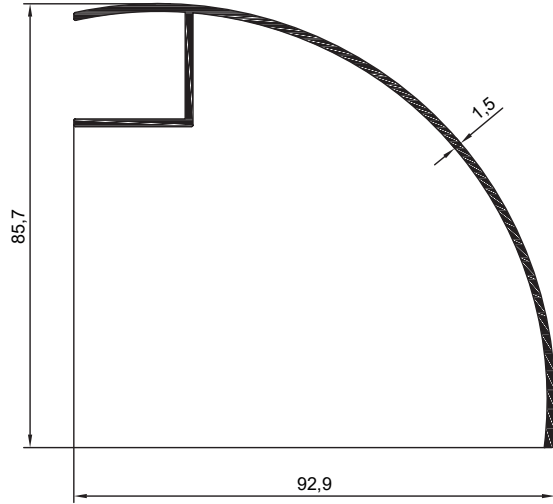

Kod / Code AA29939

Kg / m 0,765

► PULL FLUSH HANDLE

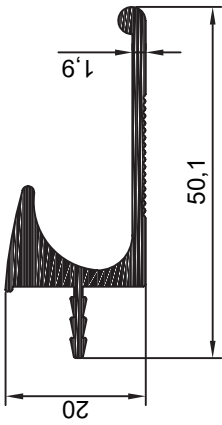

Kod / Code AA25196

Kg / m 0,534

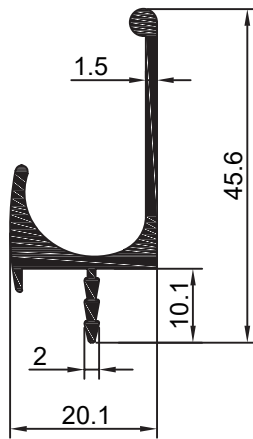

Kod / Code AA28227

Kg / m 0,421

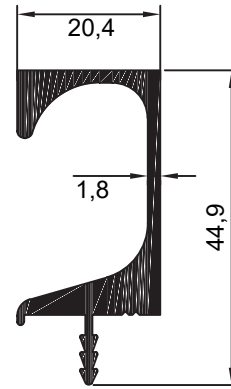

Kod / Code AA25042

Kg / m 0,651

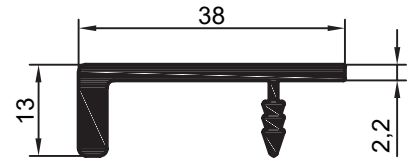

Kod / Code AA27567

Kg / m 0,403

► HEIGHT HANDLE PROFILES

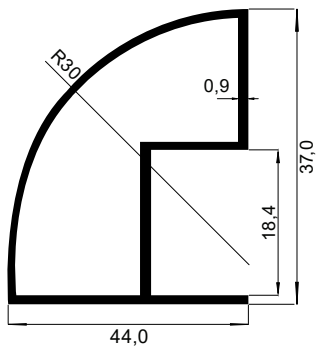

Kod / Code AA212079

Kg / m 0,317



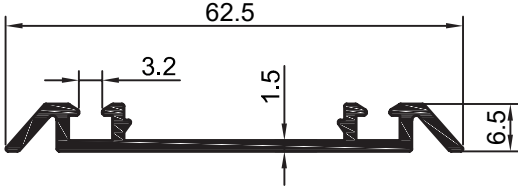

Kod / Code AA29193  
Kg / m 0,382

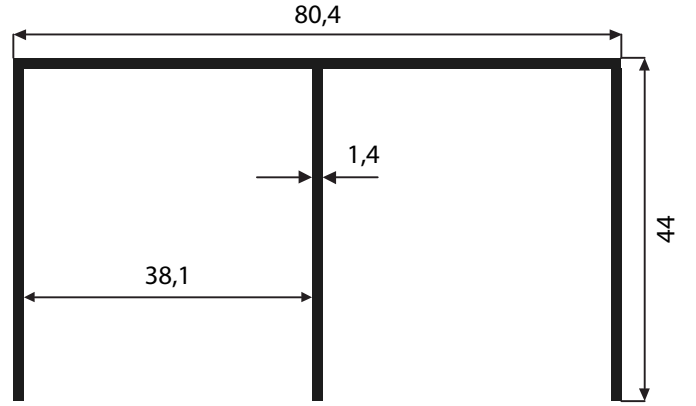

Kod / Code AA29192  
Kg / m 0,791

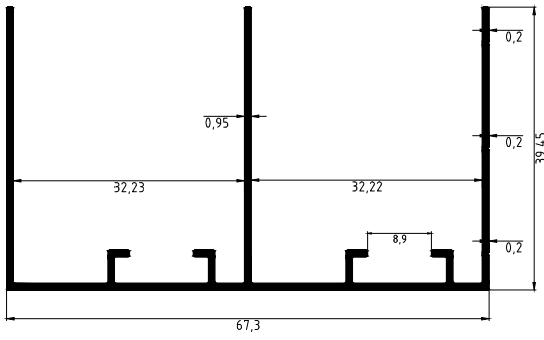

Kod / Code AA28881  
Kg / m 0,536

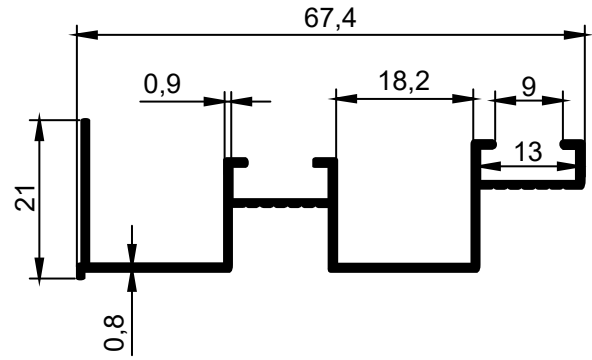

Kod / Code AA212079  
Kg / m 0,317

#### ► CURTAIN RAIL PROFILES

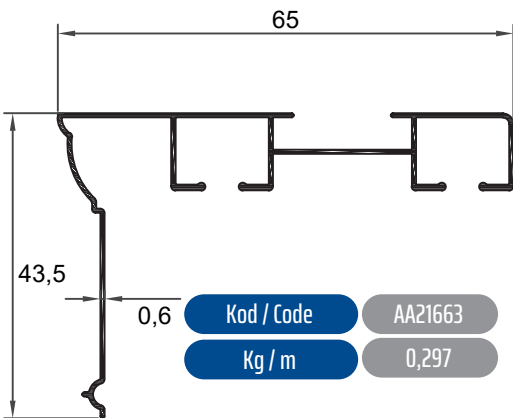

Kod / Code AA21663  
Kg / m 0,297

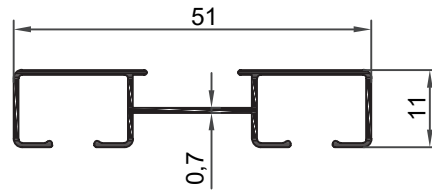

Kod / Code AA21685  
Kg / m 0,211

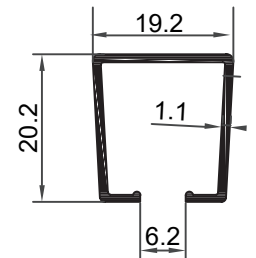

Kod / Code AA25274  
Kg / m 0,195



► CURTAIN RAIL PROFILES

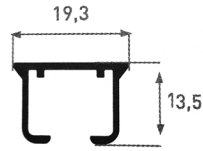

Kod / Code AA210437

Kg / m 0,161

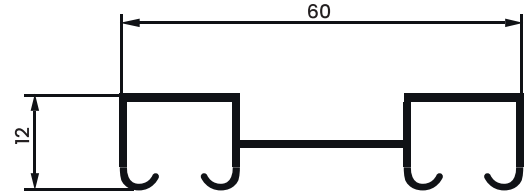

Kod / Code AA211471

Kg / m 0,380

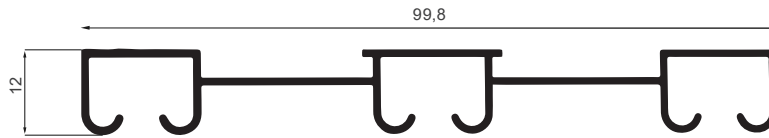

Kod / Code AA21146

Kg / m 0,535

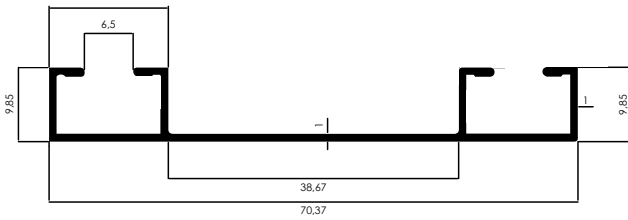

Kod / Code AA28271

Kg / m 0,350

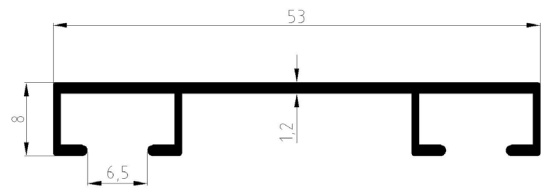

Kod / Code AA21880

Kg / m 0,275

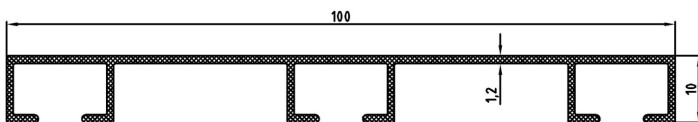

Kod / Code AA28239

Kg / m 0,540

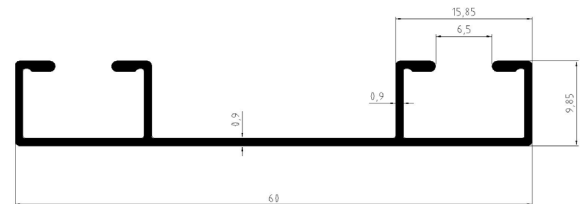

Kod / Code AA25533

Kg / m 0,290

► CHIPBOARD RETURN PROFILES

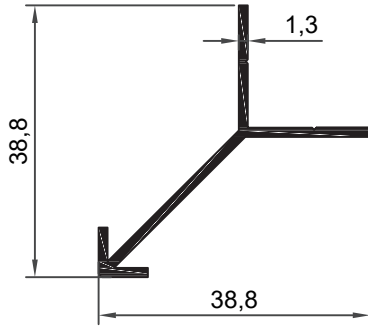

Kod / Code AA24927

Kg / m 0,265

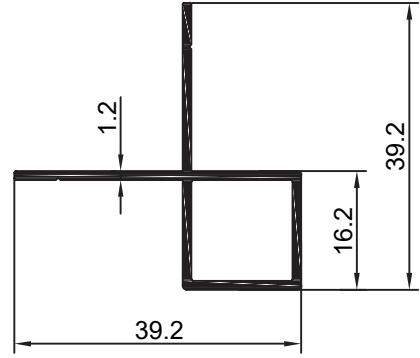

Kod / Code AA210626

Kg / m 0,313

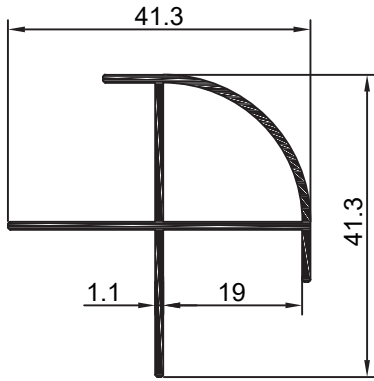

Kod / Code AA25598

Kg / m 0,376



► BOMB COVER PROFILES

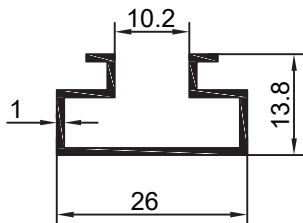

Kod / Code AA25043

Kg / m 0,192

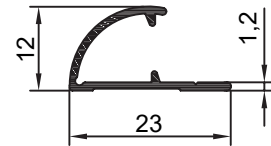

Kod / Code AA25595

Kg / m 0,122

► BASE PROFILES

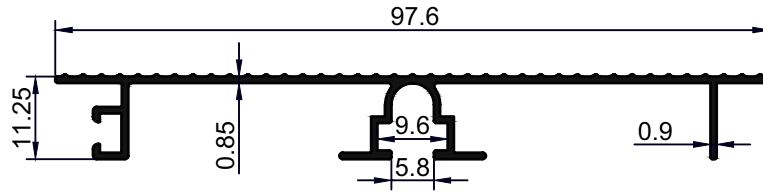

Kod / Code AA210825

Kg / m 0,410

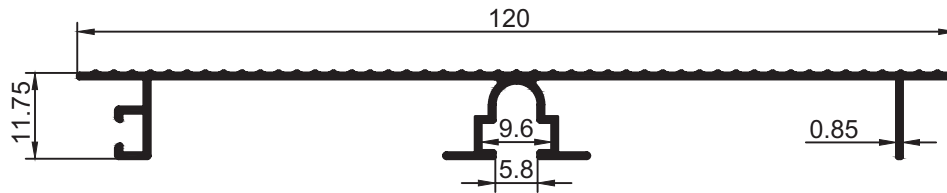

Kod / Code AA210826

Kg / m 0,473

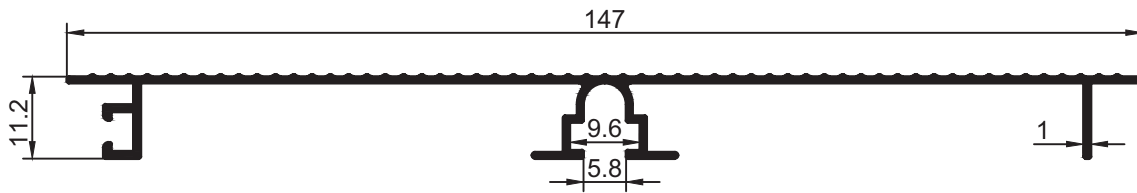

Kod / Code AA210824

Kg / m 0,567

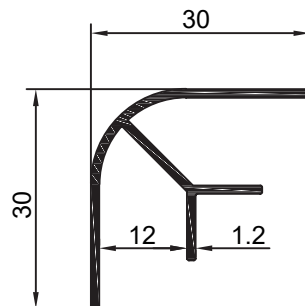

Kod / Code AA27432

Kg / m 0,265

► PROFILES OF HANGERS AND TROUSERS

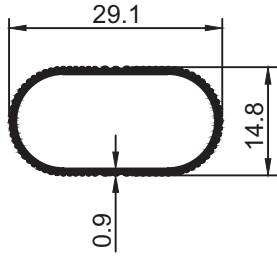

Kod / Code AA10838

Kg / m 0,151

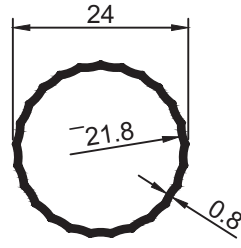

Kod / Code AA10837

Kg / m 0,159



Kod / Code AA5047

Kg / m 0,082

► LED PROFILES

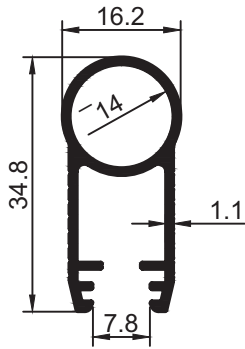

Kod / Code AA10626

Kg / m 0,313

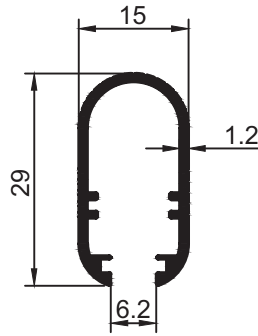

Kod / Code AA9507

Kg / m 0,245

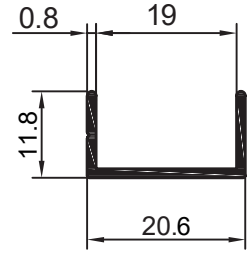

Kod / Code AA12077

Kg / m 0,100

► STEEL DOOR PROFILE

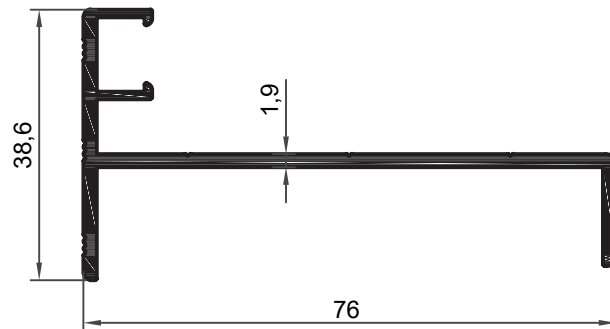

Kod / Code AA8753

Kg / m 0,698

► U CLOSURE PROFILES

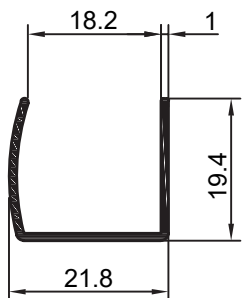

Kod / Code AA9863

Kg / m 0,155

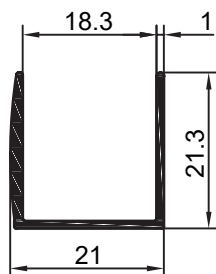

Kod / Code AA8225

Kg / m 0,189

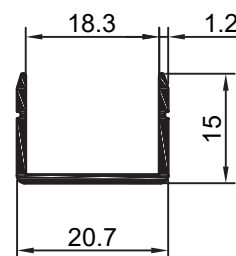

Kod / Code AA5008

Kg / m 0,150

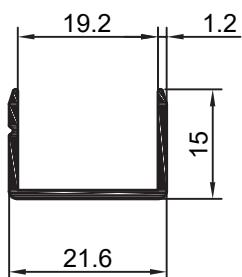

Kod / Code AA10122

Kg / m 0,154

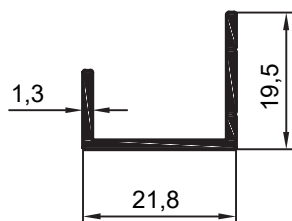

Kod / Code AA8572

Kg / m 0,175

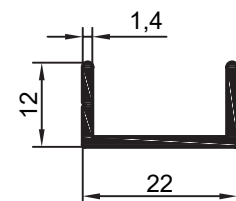

Kod / Code AA8140

Kg / m 0,162

► U CLOSURE PROFILES

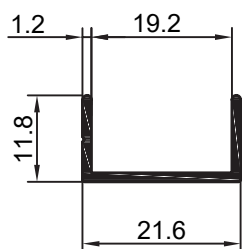

Kod / Code AA10148

Kg / m 0,138

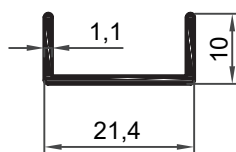

Kod / Code AA9303

Kg / m 0,116

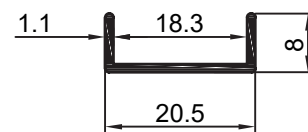

Kod / Code AA5007

Kg / m 0,101

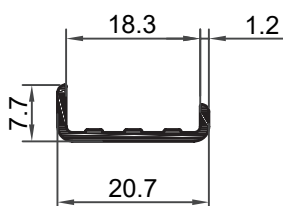

Kod / Code AA5847

Kg / m 0,103

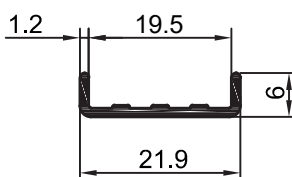

Kod / Code AA5980

Kg / m 0,106

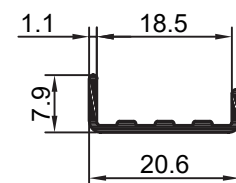

Kod / Code AA8221

Kg / m 0,097



► T PROFILES

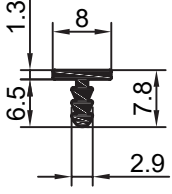

Kod / Code AA28094

Kg / m 0,066

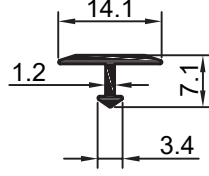

Kod / Code AA21680

Kg / m 0,064

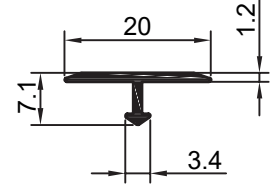

Kod / Code AA21681

Kg / m 0,083

► H PROFILES

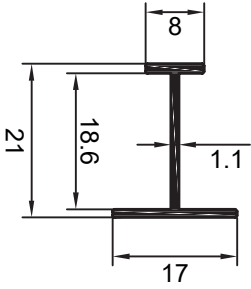

Kod / Code AA29763

Kg / m 0,134

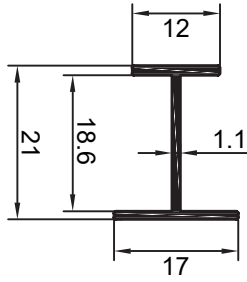

Kod / Code AA28601

Kg / m 0,148

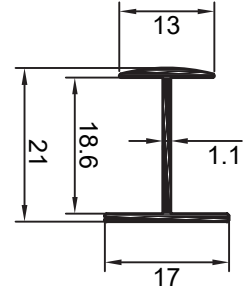

Kod / Code AA28003

Kg / m 0,141

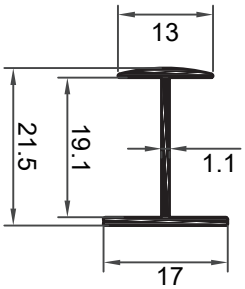

Kod / Code AA28751

Kg / m 0,143

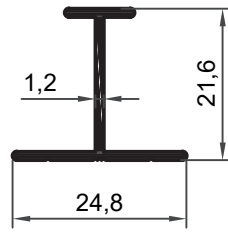

Kod / Code AA210526

Kg / m 0,172

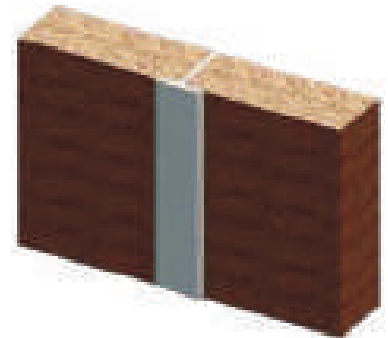

► ALUMINUM RAIL SYSTEMS

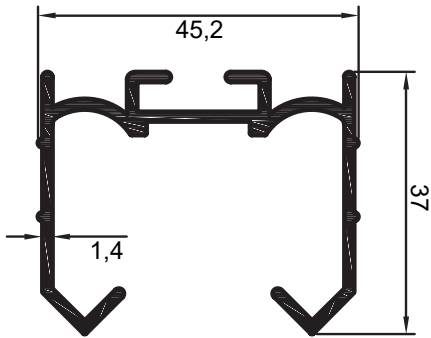

Kod / Code AA29138  
Kg / m 0,660

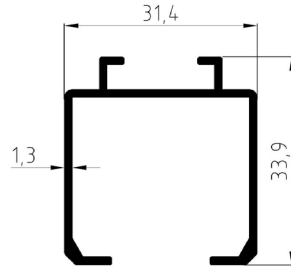

Kod / Code AA28224  
Kg / m 0,422

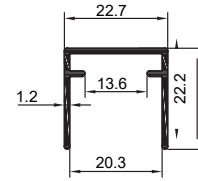

Kod / Code AA27638  
Kg / m 0,230

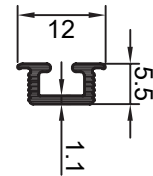

Kod / Code AA25938  
Kg / m 0,070

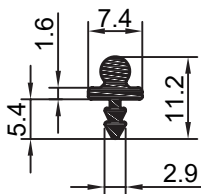

Kod / Code AA25244  
Kg / m 0,097

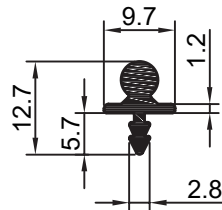

Kod / Code AA25243  
Kg / m 0,123

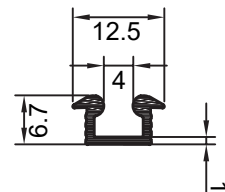

Kod / Code AA210691  
Kg / m 0,081

► PKM SERIES

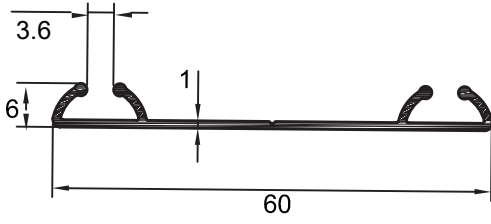

Kod / Code AA27601  
Kg / m 0,235

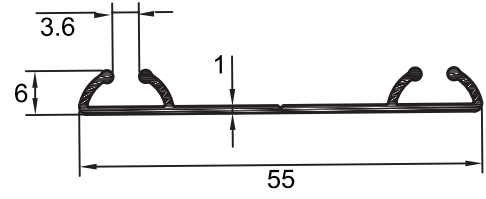

Kod / Code AA27600  
Kg / m 0,223

► SKM SERIES

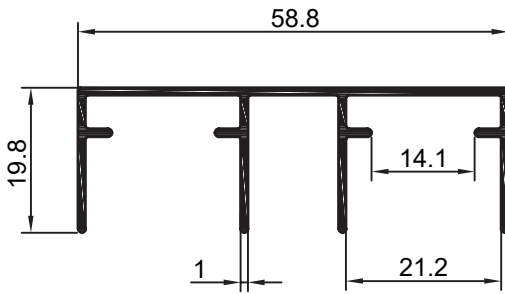

Kod / Code AA28223  
Kg / m 0,403

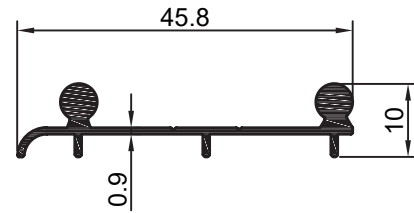

Kod / Code AA28220  
Kg / m 0,263

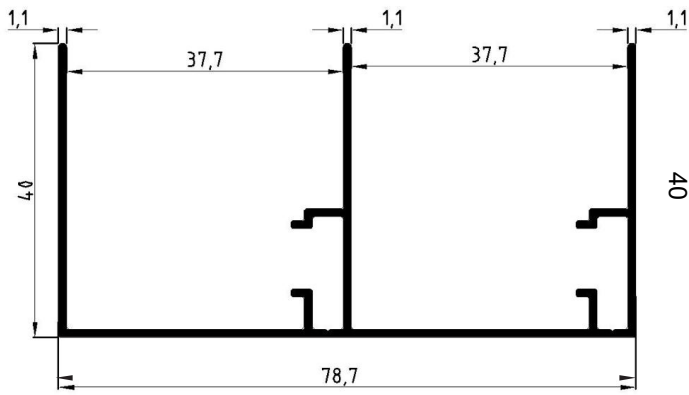

Kod / Code AA210260  
Kg / m 0,677

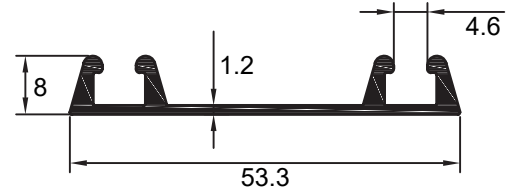

Kod / Code AA210261  
Kg / m 0,345

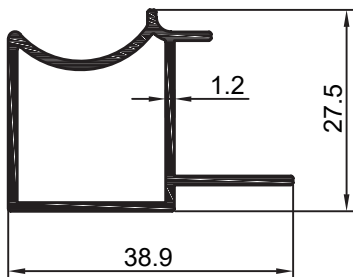

Kod / Code AA210262  
Kg / m 0,376

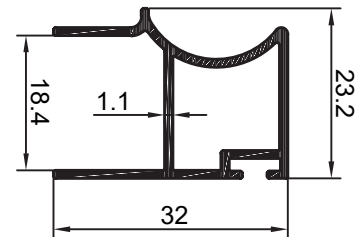

Kod / Code AA210635  
Kg / m 0,325

► ANGLE PROFILES

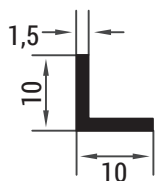

Kod / Code AA21583

Kg / m 0,075

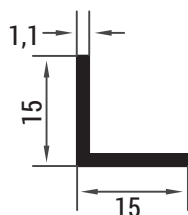

Kod / Code AA23172

Kg / m 0,85

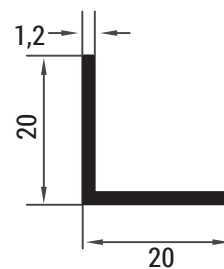

Kod / Code AA23058

Kg / m 0,126

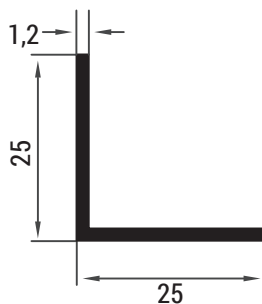

Kod / Code AA23059

Kg / m 0,158

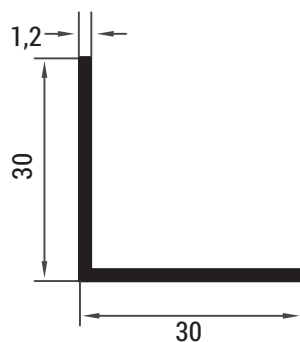

Kod / Code AA23060

Kg / m 0,191

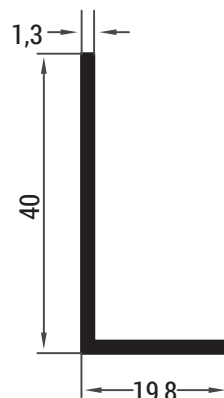

Kod / Code AA23103

Kg / m 0,206

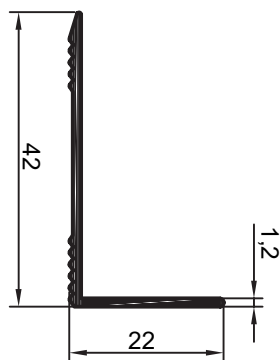

Kod / Code AA25192

Kg / m 0,209

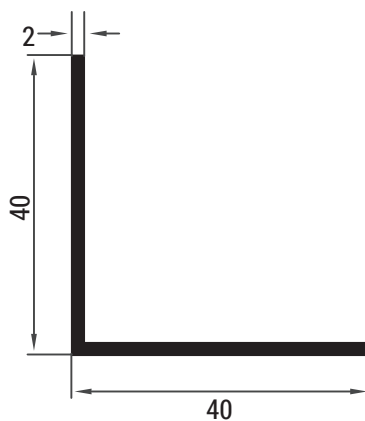

Kod / Code AA23162

Kg / m 0,422

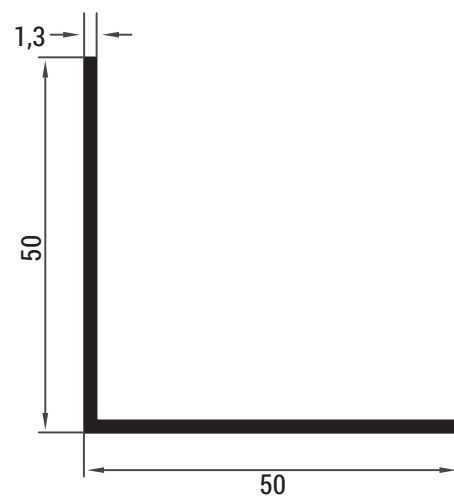

Kod / Code AA26246

Kg / m 0,347

► SLIDING COVER PROFILES

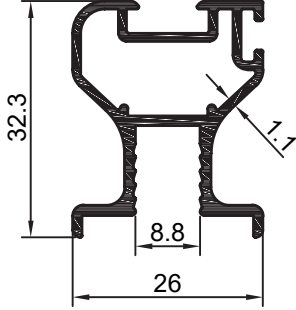

Kod / Code AA28544  
Kg / m 0,458

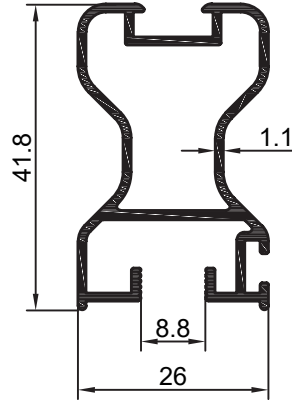

Kod / Code AA28542  
Kg / m 0,522

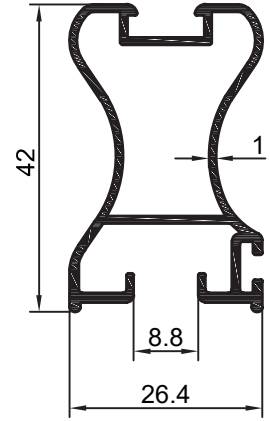

Kod / Code AA210413  
Kg / m 0,481

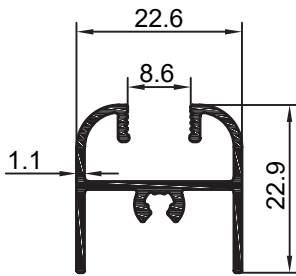

Kod / Code AA28547  
Kg / m 0,285

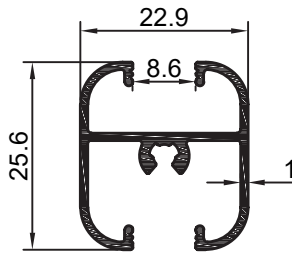

Kod / Code AA28545  
Kg / m 0,303

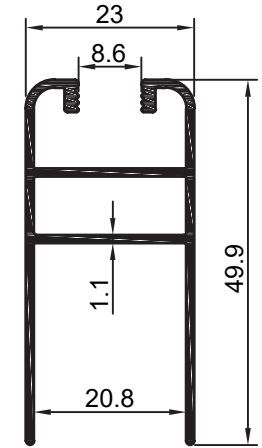

Kod / Code AA28543  
Kg / m 0,479

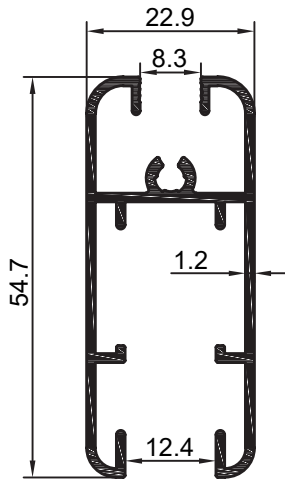

Kod / Code AA28602  
Kg / m 0,617

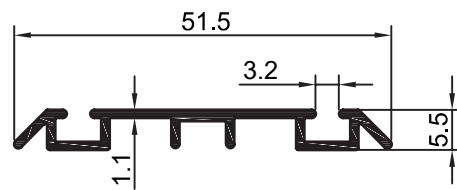

Kod / Code AA28546  
Kg / m 0,263



► HEIGHT HANDLE PROFILES

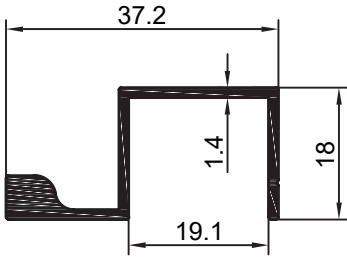

Kod / Code AA28853  
Kg / m 0,340

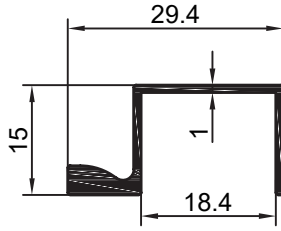

Kod / Code AA29838  
Kg / m 0,210

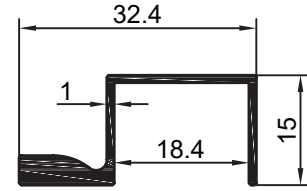

Kod / Code AA29260  
Kg / m 0,242

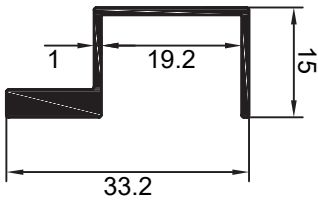

Kod / Code AA29286  
Kg / m 0,256

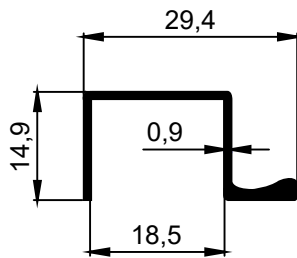

Kod / Code AA212087  
Kg / m 0,163

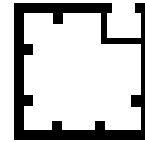

Kod / Code AA26301  
Kg / m 0,250

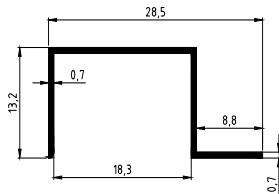

Kod / Code AA28728  
Kg / m 0,110

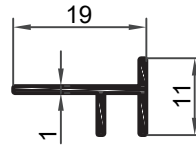

Kod / Code AA29470  
Kg / m 0,095



► SILL CLOSURE AND SKIRTING BOARD PROFILES

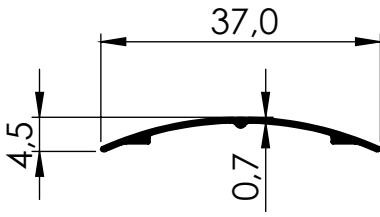

Kod / Code AA25400

Kg / m 0,087

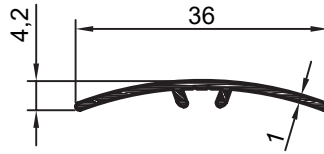

Kod / Code AA25191

Kg / m 0,117

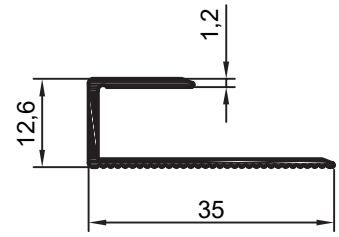

Kod / Code AA25422

Kg / m 0,174

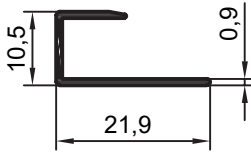

Kod / Code AA25285

Kg / m 0,097

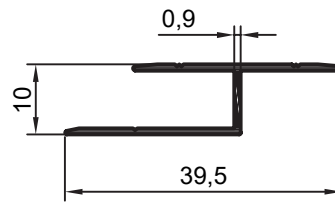

Kod / Code AA25186

Kg / m 0,148

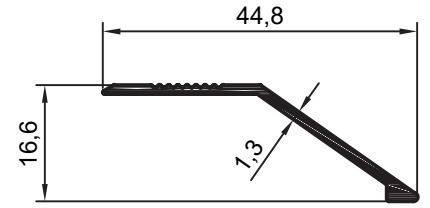

Kod / Code AA25193

Kg / m 0,177

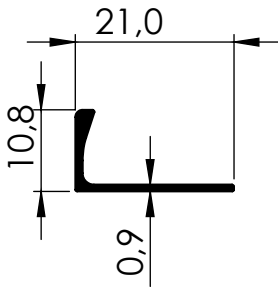

Kod / Code AA21897

Kg / m 0,093

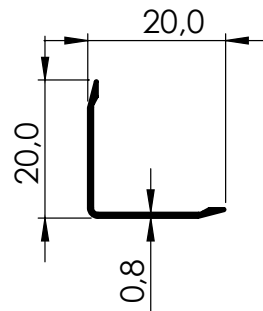

Kod / Code AA21897

Kg / m 0,093

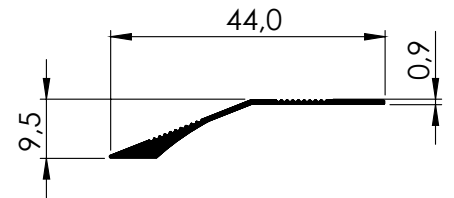

Kod / Code AA21782

Kg / m 0,087

► MARBLE PROFILES

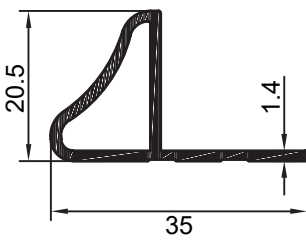

Kod / Code AA27902

Kg / m 0,584

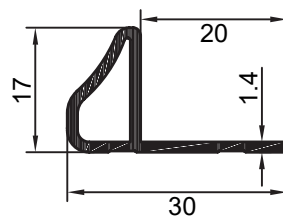

Kod / Code AA210540

Kg / m 0,232

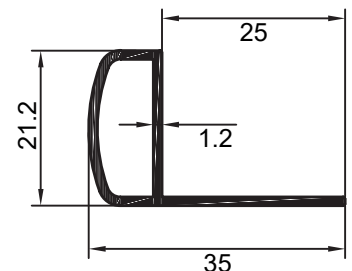

Kod / Code AA29760

Kg / m 0,254

► GOLA SERIES (HIDDEN CUP PROFILES)

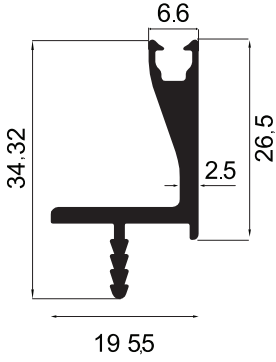

Kod / Code AA28789  
Kg / m 0.382

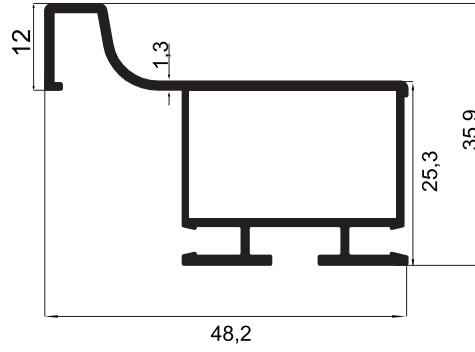

Kod / Code AA28792  
Kg / m 0.621

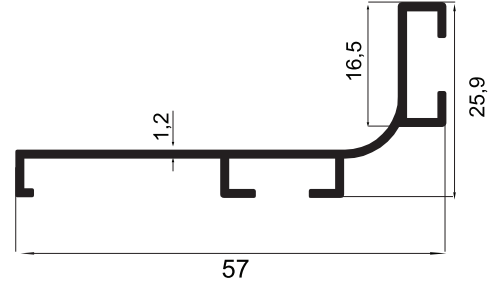

Kod / Code AA28794  
Kg / m 0.358

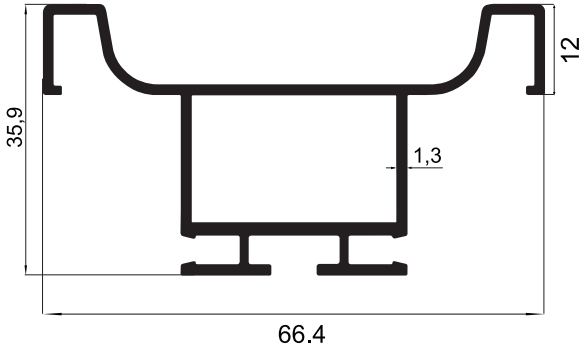

Kod / Code AA28793  
Kg / m 0.760

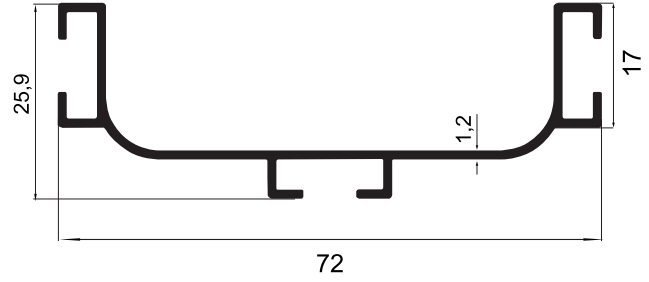

Kod / Code AA28795  
Kg / m 0.482

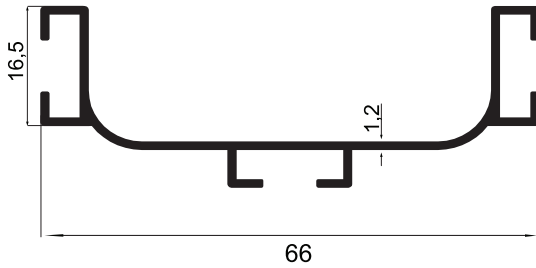

Kod / Code AA29144  
Kg / m 0.463

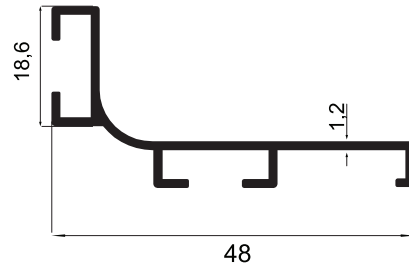

Kod / Code AA29145  
Kg / m 0.329

► ANGLE PROFILES

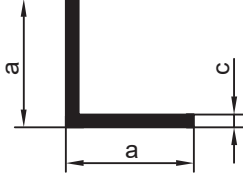

PROFİL NO	a mm	c mm	Kg/m
1583	10	1.5	0.075
6931	12	2	0.118
3172	15	1.1	0.084
1575	15	1.5	0.115
8025	15	2.8	0.206
3058	20	1.2	0.126
6420	20	1.6	0.166
3136	20	1.9	0.196
5968	20	8	0.693
3059	25	1.2	0.100
6421	25	1.6	0.209
3256	25	2	0.260
3840	25	3	0.382
8865	25	5	0.610
1241	30	1	0.159
3060	30	1.2	0.191
3901	30	1.5	0.237
10355	30	2	0.314
1631	30	3	0.463
6422	40	1.2	0.256
3162	40	2	0.422
4077	40	3	0.626
1212	40	4	0.823
4723	40.4	4.4	0.823
3944	40	4.7	0.959
4056	40	5	1.016
7472	45	2	0.476
6246	50	1.3	0.347
6752	50	2	0.530
4386	50	3	0.787
10100	50	4	1.040
*9572	50	5	1.301
1211	50	5	1.287
9919	55	5	1.423
4811	60	2	0.638
8177	60	6	1.853
*5209	90	48	17.167

► LAMA PROFILES

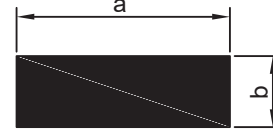

PROFİL NO	a mm	b mm	Kg/m
6587	10	2	0.054
4028	12	1.6	0.052
6941	12	2.5	0.081
4941	12	3	0.097
8705	12	5	0.262
8926	13.9	8.9	0.335
7474	15	2	0.081
3229	15	2.5	0.100
6559	15	3	0.121
3718	15	3.1	0.126
6630	18	2.5	0.121
1573	20	2	0.108
3121	20	4.5	0.241
1243	20	5	0.271
1487	25	2	0.135
3708	25	2.5	0.196
3594	25	3	0.203
3441	25	5	0.338
8706	27	16	1.171
4312	30	2	0.162
7352	30	4	0.325
3202	30	6	0.487
4026	30	6.75	0.548
7863	30	10	0.813
6221	40	2	0.216
4534	40	3	0.325
9165	40	4	0.433
*3948	44	9.8	1.167
7341	45	12	1.463
10064	46	4	0.498
9675	55	4	0.596
9798	60	1.4	0.228
3532	60	2	0.325
7673	60	4	0.650
8618	65	14	2.466
6287	70	3	0.569
10811	70	4	0.759
5270	75	7	1.422
3176	100	3.5	0.939
3204	105	2	0.569

## ► T PROFILES

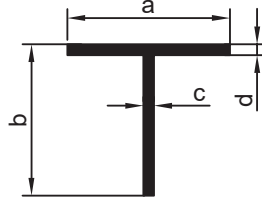

PROFİL NO	a mm	b mm	c mm	d mm	Kg/m
5844	13	15	3	3	0.203
5987	13.7	15.4	2.5	2	0.164
4681	15	15	1.2	1.2	0.093
4680	20	20	1.2	1.2	0.126
1354	20	20	1.1	1.1	0.115
6361	20	20	2	2	0.205
3265	20	40	3	3	0.463
3062	25	25	1.2	1-2	0.158
8866	25	35	5	5	0.745
6341	30	15	1.5	1.5	0.176
3063	30	30	1.2	1.2	0.189
4674	30	30	2	2	0.312
4233	35	35	1.7	1.7	0.314
7478	50	30	4	4	0.824
7473	50	37.5	5	2.5	0.812
6312	50	50	2	2	0.531
6652	50	50	5	5	1.287
8931	70	50	3	3	0.950

## ► ROUND BARS

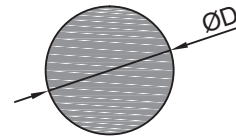
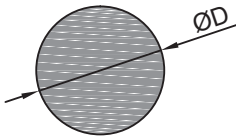

PROFİL NO	ØD mm	Kg/m
3070	8	0.136
3497	10	0.212
4275	12	0.306
4300	25	1.330
9454	25.5	1.384
3634	26	1.438
7682	28	1.668
3071	30	1.915
3637	35	2.607
5280	36.3	2.804
4178	40	3.405

PROFİL NO	ØD mm	Kg/m
6365	42.7	3.880
3632	44	4.120
9157	45	4.310
4177	50	5.321
3670	53	5.978
7931	55	6.438
3823	56	6.664
4240	60	7.662
5333	68	9.841
4881	77	12.619



## Integrated Handle (Apache)

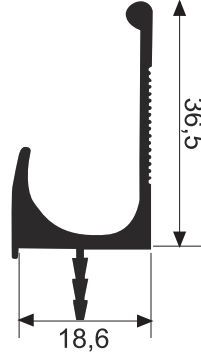

## Code AA2001

Dimensions	
147 mm	597 mm
197 mm	697 mm
247 mm	797 mm
297 mm	897 mm
347 mm	997 mm
397 mm	Özel Ölçü
447 mm	
497 mm	
547 mm	

## Integrated Handle Ç

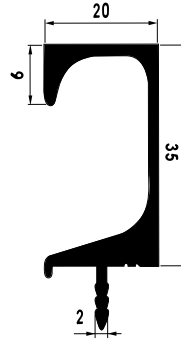

## Code AA2002

Dimensions	
147 mm	597 mm
197 mm	697 mm
247 mm	797 mm
297 mm	897 mm
347 mm	997 mm
397 mm	Özel Ölçü
447 mm	
497 mm	
547 mm	

## Integrated Handle

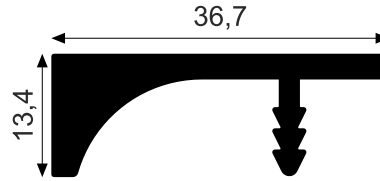

## Code AA2003

Dimensions	
147 mm	597 mm
197 mm	697 mm
247 mm	797 mm
297 mm	897 mm
347 mm	997 mm
397 mm	Özel Ölçü
447 mm	
497 mm	
547 mm	

## Integrated Handle

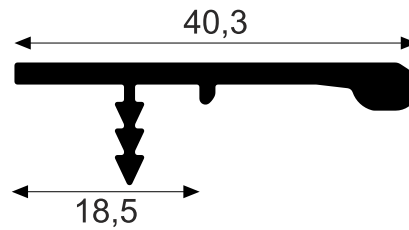
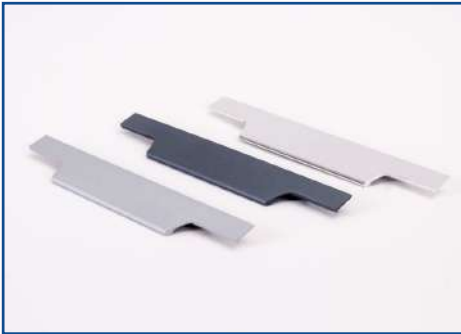

## Code AA2004

Dimensions	
147 mm	597 mm
197 mm	697 mm
247 mm	797 mm
297 mm	897 mm
347 mm	997 mm
397 mm	Özel Ölçü
447 mm	
497 mm	
547 mm	

### Color Codes

01- Chemical Bright

02- Mechanical (Brush) Bright

03- Matte

04- Yellow

05- Black

06- Inox

07- Bronze

08- Copper

09- Anthracite

10- Chrome

## Code AA2005

Dimensions	
147 mm	597 mm
197 mm	697 mm
247 mm	797 mm
297 mm	897 mm
347 mm	997 mm
397 mm	Özel Ölçü
447 mm	
497 mm	
547 mm	

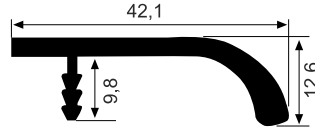

### Integrated Handle Oval

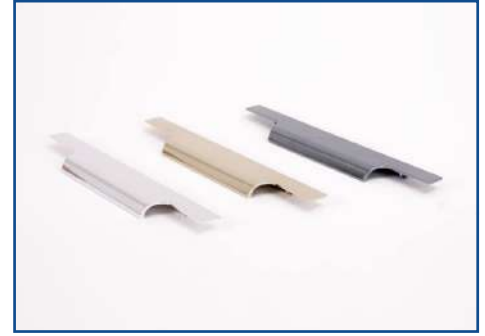

## Code AA2006

Dimensions	
147 mm	597 mm
197 mm	697 mm
247 mm	797 mm
297 mm	897 mm
347 mm	997 mm
397 mm	Özel Ölçü
447 mm	
497 mm	
547 mm	



### Integrated Handle L

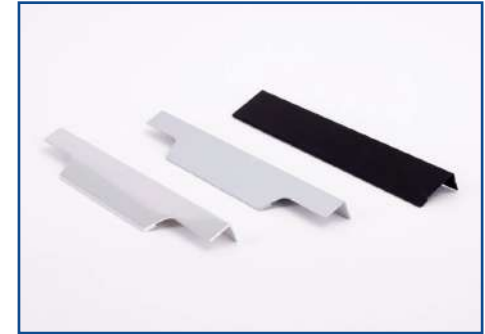

## Code AA2007 Code AA2008

Dimensions	
147 mm	597 mm
197 mm	697 mm
247 mm	797 mm
297 mm	897 mm
347 mm	997 mm
397 mm	Özel Ölçü
447 mm	
497 mm	
547 mm	

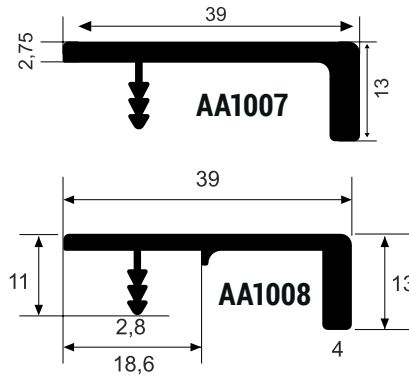

### Integrated Handle



## Code AA2009

Dimensions	
147 mm	597 mm
197 mm	697 mm
247 mm	797 mm
297 mm	897 mm
347 mm	997 mm
397 mm	Özel Ölçü
447 mm	
497 mm	
547 mm	

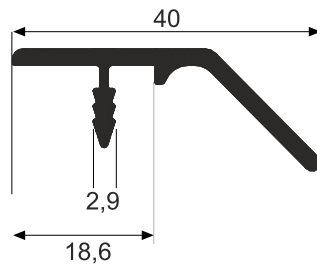

### Integrated Handle 45°



#### Color Codes

01- Chemical Bright

02- Mechanical (Brush) Bright

03- Matte

04- Yellow

05- Black

06- Inox

07- Bronze

08- Copper

09- Anthracite

10- Chrome

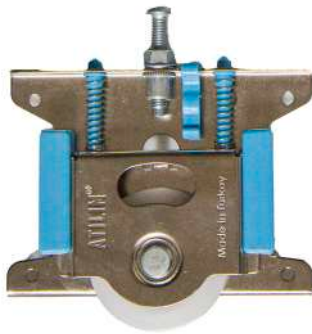

PKM80 PRO

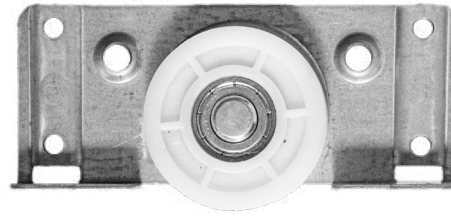

SLIDING CABINET CASTER



PKM80

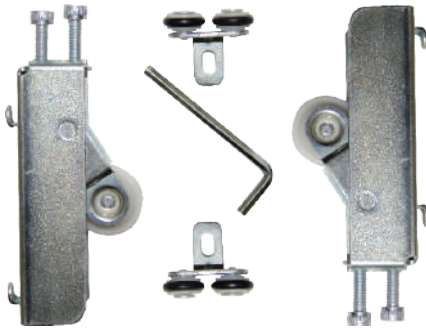

GAMMA SLIDING COVER MECHANISM



BETA SLIDING COVER MECHANISM



IN-RAIL DECELERATOR BRAKE



DECELERATOR BOX BRAKE



STAR CORNER BEAD



FLAT CORNER SHEET



RIGHT-LEFT GUIDE

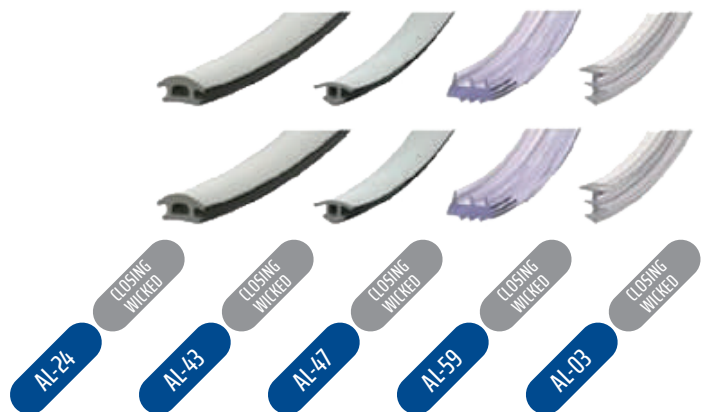

AL-24

AL-43

AL-47

AL-59

AL-03



**DOOR SLIDING MECHANISM WITH BEARING**

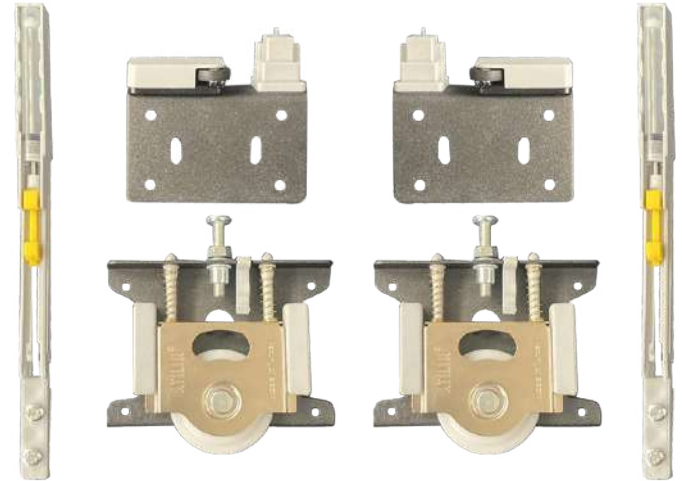

**JUNIOR COVER MECHANISM PRO**



**JUNIOR COVER MECHANISM**



**80KG DOOR SLIDING MECHANISM**





**ATILIM ALÜMİNYUM**

Atılım Alüminyum San. ve Tic. Ltd. Şti.  
[www.atilimaluminyum.com.tr](http://www.atilimaluminyum.com.tr)  
+90 212 679 17 74  
[info@atilimaluminyum.com.tr](mailto:info@atilimaluminyum.com.tr)